

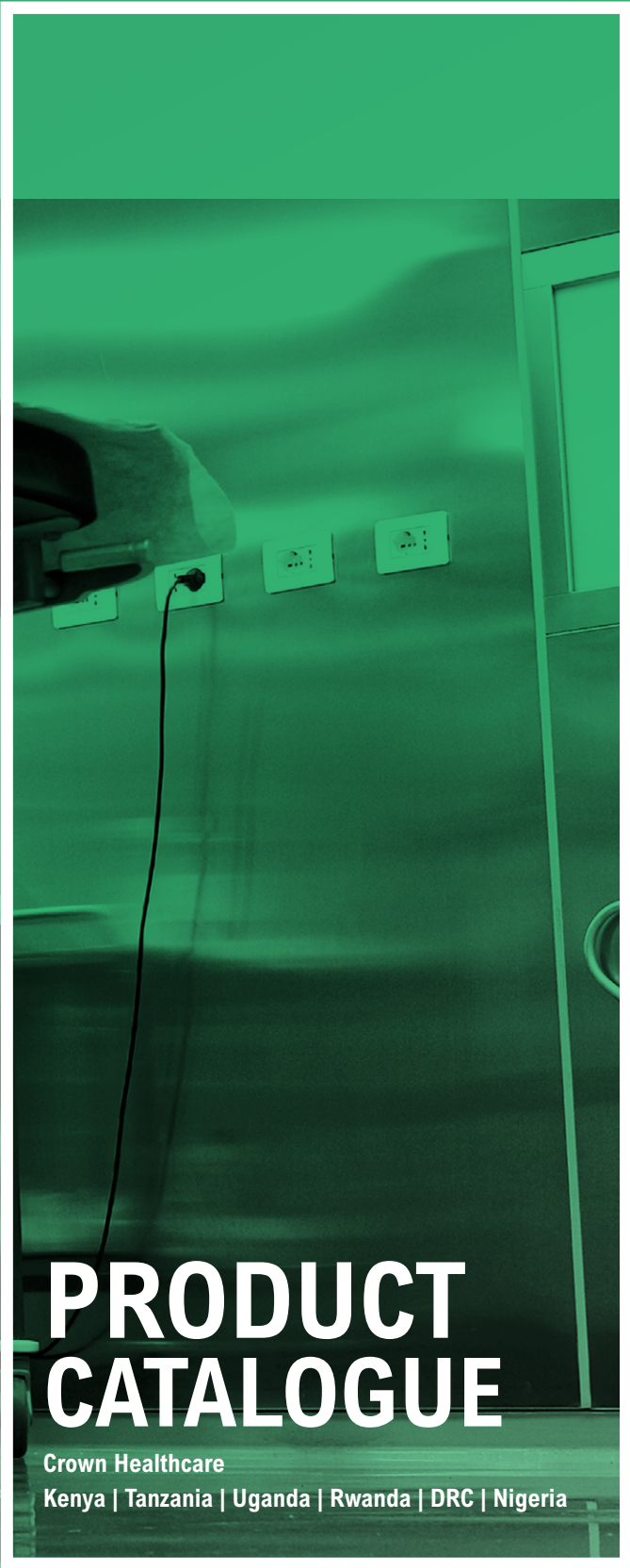

**CROWN**  
HEALTHCARE



# PRODUCT CATALOGUE

Crown Healthcare  
Kenya | Tanzania | Uganda | Rwanda | DRC | Nigeria



## Treating patients across Africa since 1998

Crown Healthcare is a privately owned Kenyan company that was established in 1998. Over the last eighteen years we have established ourselves as the preferred provider of world class medical equipment and supplies across the African region.

With divisional offices in Tanzania, Uganda, Rwanda, and Nigeria we are able to provide our expertise to our customers on time, every time.

Our team is educated and continuously trained in the latest technologies and innovations happening within surgical and healthcare industry.

- Global partnerships and synergies to ensure we stock the latest healthcare, medical and surgical products in-line with global trends
- Creating jobs and helping communities across the entire Crown Healthcare footprint
- Continuous training for all team members to ensure we provide expert advice and training on innovations across the product portfolio

### Benefits of doing business with Crown Healthcare

- +50 years combined senior management experience in the Healthcare Industry
- International facilities in place to cater to growing demand
- Quality sourced healthcare, medical and surgical products to ensure competitive pricing



## Our Values

### Customer Focus

We are friendly and responsive to clients. We deliver solutions to meet our clients requirements

### Integrity

We believe in individual and corporate honesty. We are accountable to our clients and stakeholders

### Teamwork

We believe in teamwork to achieve our corporate objectives. We share knowledge and work.

### Responsibility

We believe that well-being of the community and environment is our collective responsibility. We practice good governance to deliver value to our clients, employees and shareholders.

### Recognition

We recognize talents and contributions of each team member of our company. We appreciate and reward excellence.

7-20



## BASIC EQUIPMENT

- BP Machines
- Stethoscopes
- Diagnostic Sets
- Medical Lighting
- Thermometers
- Nebulizers
- Portable ECG Machines
- Ambu Bags
- Body Fat Monitors

35-46



## NONPHARMACEUTICAL

- Cotton Dressing
- Sterile Dressing
- Bandage & Plasters
- Gloves
- Face Masks & Surgical Caps
- Tubing & Clamps
- Blood Bags
- Urology
- Sutures
- First Aid Boxes
- Accessories

55-62



## INFANT & MATERNAL

- Fetal Doppler
- Suction Machines
- Vacuum Extractors
- Fetal Monitor
- Incubators
- Infant Warmers & Resuscitator
- Photo therapy Unit
- Colposcopes

71-92



## THEATER SOLUTIONS

- Operating Tables
- Operating Lights
- Examination Lights
- Suction Machine
- Anesthesia
- Endoscope
- Diathermy Machines
- Surgical Instruments
- Orthopedic
- Holloware
- Incubators
- Infant Warmers
- Surgical Implants

21-34



## MEDICAL SCALES

- Pediatric Scales & Measuring System
- Measuring Stations & Column Scales
- Flat Scales
- Height Measuring Systems
- Multi-functional & Wheelchair Scales
- Specialized Scales
- Seca mBCA

47-54



## PHARMACEUTICAL

- Crown Brands
- Healthcare Pharmaceuticals Ltd
- Brookes Pharmaceuticals Ltd
- Apoorv Nutra Pharm PVT Ltd
- S.Kant Healthcare Ltd
- Aculife Healthcare

63-70



## HOSPITAL FURNITURE

- Hospital Beds
- Home Care Beds
- Delivery/Examination Beds
- Infant/Pediatric
- Bed Side Lockers
- IV Stands
- Trolley / Carts
- Stretchers / Instrument Cupboards
- Hospital Linen
- Medical Curtains / PVC Floor
- Accessories

93-104



## ICU SOLUTIONS

- Pendants
- Patient Monitors
- Deibrillators
- Ventilators
- Syringe Pumps
- Infusion Pumps
- Bbraun ICU/OR Systems

105-106



## RENAL SOLUTIONS

- Dialysis Machine
- Reverse Osmosis Plant
- Consumable

123-166



## LABORATORY

- Chemistry Analyzers
- Hematology Analyzers
- Electrolyte Analyzers
- Glucometers
- Coagulation Analyzers
- Microscopy
- Incubators
- Immunoassay
- Centrifuges & Roller Mixers
- Water Baths
- Safety Cabinets
- Hot Air Ovens
- Pipettes & Balances
- Ortho Clinical Diagnostics
- Urine Analyzers

179-196

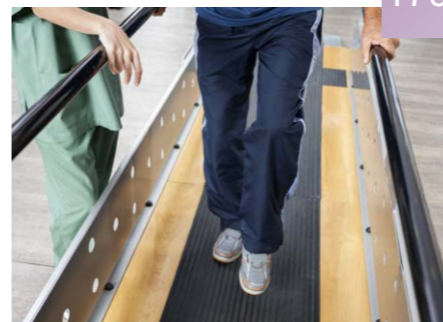

## PHYSIOTHERAPY

- Wheel Chairs
- Crutches
- Walking Aids
- Walking Frames
- Commode Chairs
- Orthopaedic Supports

203-210



## GAS SOLUTIONS

- Vision Aire
- Sure Flow
- Newlife Intensity
- Free Style
- Pendants, Flowmeter & Bed heads
- Oxygen Set
- CPX Suction Ring
- Brass Munsen Ring
- Degreased Medical Copper Tube
- Degreased Medical Gas Copper Fittings
- Medical Lockable Line Valve

107-122



## IMAGING SOLUTIONS

- Ultrasounds
- X-ray Systems
- X-ray Printers
- X-ray Protection
- X-ray Accessories
- X-ray Consumables
- Ami X-ray Systems

167-178



## DENTAL SOLUTIONS

- Dental Units
- Imaging
- Digital Imaging System
- Orthodontics
- Endodontics
- Scalars
- Dental Compressors
- Dental Furniture

197-202



## REFRIGERATION

- Pharmacy Fridges
- Solar Vaccine Fridges
- Ice Lined Fridges
- Blood Bank Fridges
- Deep Freezers Fridges
- Blood Transport Boxes
- Biological Safety Cabinets

211-216

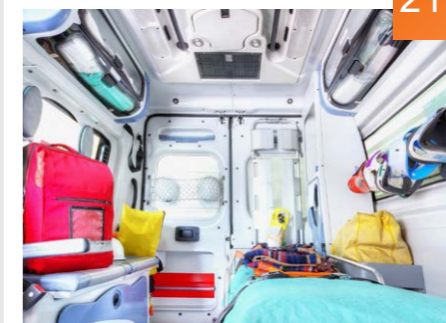

## AMBULANCE SETUP

- Ambulance Accessories
- Vehicle Conversion
- Standard Equipment
- Optional Equipment

217-222



## STERILIZATION

- Steam Sterilizers
- Sterilization Pouches
- Automatic Autoclaves
- Manual Autoclaves
- Accessories

223-234



## ORTHOPAEDIC

- DHS & DCS
- Trauma Plates
- Interlocking Intramedullary Nails
- Orthopedic Instruments
- Locking Compression Plates Systems
- Screws

235-248



## Holloware

- Scissors
- Forceps
- Retractors/Towel Clamps
- Needle Holders
- Gynecological Instruments
- Percussion Hammers
- Instrument Tray
- Oral Instruments
- Jars, Sterilizers & Bins



## BASIC EQUIPMENT

- BP Machines
- Stethoscopes
- Diagnostic Sets
- Medical Lighting
- Thermometers
- Nebulizers
- Portable ECG Machines
- Ambu Bags
- Body Fat Monitors

# BP MACHINES

## Arm & Professional



### M2 Basic

These arm blood pressure monitors give you an easy way to check for hypertension and track changes in your health and fitness.

- One button operation
- Easy to read LCD display
- One size cuff fits all
- Clinically tested



### M2 Eco

The OMRON M2 Eco is a compact, fully automatic upper arm blood pressure monitor, operating on the oscillometric principle. It measures your blood pressure and pulse rate simply and quickly.

- Systolic and diastolic blood pressure measurement
- Pulse display
- Arm Cuff 22-32 cm
- Battery Set



### Blood Pressure Monitor Wrist

- Intellisense™ technology
- Three-fold Displays (Sys/Dia/Pulse)
- Large Display & Operation Buttons
- Cuf wrapping guide
- Affordable and Easy to use
- Automated sensor, detectors & Guide for accurate result
- Clinically Validated



### Blood Pressure Monitor Wrist

- Intellisense™ technology
- It automatically displays the average of up to the last 3 readings taken over a 10 minute period.
- NFC Connectivity + free access to Bi-Link Health Management Platform
- APS (Advanced Positioning Sensor)
- Three-fold Displays (Sys/Dia/Pulse)
- Date/Time Indication with Large Display & Operation Buttons
- Cuf wrapping guide
- Irregular Pulse Detection

BP Monitoring made simple

## Professional Units



### M2

- Fully automatic upper arm pressure monitor
- Intellisense™ technology
- Optional large/small cuff available
- Cuf wrapping guide
- Irregular heartbeat detection
- Blood pressure level bar
- 30 memory position
- Clinically validated (International Protocol)



### M3

- Fully automatic upper arm blood pressure monitor
- Intellisense™ technology
- Advanced averaging mode
- Clinically validated (International Protocol)
- Easy high blood Pressure indicator
- Cuf wrapping guide
- Irregular heartbeat & body movement detection
- Memory capacity for 60 readings with date & time stamp



### M6 Comfort

- Fully automatic upper arm blood pressure monitor
- Intellisense™ technology
- Easy blood pressure indicator
- Cuf wrapping guide
- Morning Hypertension detection
- Irregular heartbeat and body movement detection
- Memory capacity for 90 readings
- Advanced averaging mode
- Clinically validated (International Protocol & BHS)
- Dual sized comfort cuff (22-42cm)

Easy to read LCD display



### 907

- Programmable average of multiple measurements
- Hide function for readings
- Clinical validated (international protocol)
- Oscillometric & auscultatory measurement possible
- Digital automatic upper arm model for professional use
- Supplied with rechargeable batteries & adapter
- *Optional Trolley Available*



### HBP 1100E

- 5 Cuf sizes: from pediatric to XL, it's a wider range of patients
- Dual measurement modes: switch from Oscillometric
- Mode to Manual Auscultation Mode depending on the patient's conditions.
- Zero Indicator: shows the device resets to zero pressure level, indicating that it is ready for the next measurement
- Simple interface for frequent use

# BP MACHINES

## SPHYGMOMANOMETERS



### Diplomat Presameter Desk Model



- Maximum error tolerance of +/-3mmHg
- Precision glass column  
Internal diameter 4.2 mm +/-0.2 mm
- Latex bulb with chromium plated air release valve
- Precision air release valve, wear-free and with ine regulation
- Microilter for long life
- Nickel plated metal parts
- Cuf with two-tube latex bladder
- Easily legible metal scale up to 300mmHg
- Mercury lock



### Babyphon

Palm-style sphygmomanometer specially designed for pediatrician's offices and hospitals. Suitable for children.

- Ergonomic spoon-shaped handle made of stainless steel
- Precision pressure-release valve, permits ine regulation and is non-wearing
- Micro-ilter protects pressure-release valve & measurement system
- Special hardened copper-beryllium membranes, virtually unchangeable precision workings
- Membrane can withstand over pressures of up to 600 mm
- Linear scale, up to 300 mm Hg
- Maximum error tolerance of +/- 3 mm Hg
- Also available as a non-latex mod



### Ri-San Aneroid

- Latex-free bulb
- Tube connection at the top of the pressure gage for unhindered blood pressure measurement
- Precision air-release valve with ine adjustment
- Microilter protects air release valve and measuring system
- Specially tempered copper-beryllium diaphragm resists aging
- Diaphragm can be pressurized up to 600 mmHg
- Easily legible scale 64 from 0 to 300 mmHg with maximum error tolerance of 3 mmHg
- Latex-free, black hook and loop adult cuff (54.5 X 14.5 cm)
- Vinyl zippered case



### empire n-Wall Model

- Maximum error tolerance of +/-3mmHg
- 99.99% pure mercury
- Precision glass column
- Internal diameter 4.2 mm +/-0.2 mm
- Latex bulb with chromium plated air release valve
- Precision air release valve, wear-free and with ine regulation
- Microilter for long life
- Cuf with two-tube latex bladder
- Easily legible scale up to 300 mmHg
- Mercury lock
- Coil tubing extendible up to 3m

### Big Ben Wall Models



- Generously dimensioned scale (Ø 147 mm (5.8 in) or 145 mm (5.7 in) and high-contrast scale layout for optimum readability.
- Spacious basket on the reverse side for tubes and cuff.
- Spiral tube can be extended to 3m (118.1 in).
- Non-wearing air-release valve with ine adjustment.
- Specially hardened copper-beryllium membrane, resistant to aging, can withstand pressures of up to maximum 600 mm Hg
- Micro-ilter to protect the release valve and measurement system
- No zero-point fixation required
- Maximum error tolerance: ± 3 mm Hg



# BP MACHINES

## SPHYGMOMANOMETERS (Mercury/Aneroid)

Precision

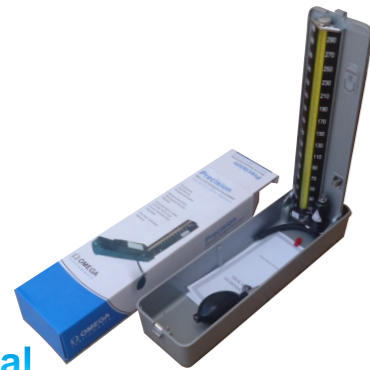

### Mercurial Sphygmomanometer

- Maximum error tolerance of +/- 2 mmHg.
- 99.99% pure Mercury.
- Precision glass column internal diameter 4.2 mm +/- 0.2 mm (0.17 in +/- 0.1 in)
- Precision air release valve, wear-free and with ine regulation.
- Microfilters to protect the measuring system and against mercury pollution.
- Two-tube bladder cuffs with plastic plug-in type connector.
- Metal faceplate with easy-to-read scale up to 300 mm
- Mercury lock
- Large storage compartment for cuff and bulb.
- Cleaning device for glass column.
- Full range of bladder cuff sizes and designs.



### Aneroid Sphygmomanometer

- Built to EN1060 -1/2 Standards
- Scale Grading: 2mmhg
- Measurement Range:0-300mmhg
- Measurement Precision + 3mmhg
- The Lowest Value On The Scale Is "0", the Aneroid needle in the "0" Position must be with in Tolerance of ± 3mmhg

# STETHOSCOPES

## ACOUSTIC CLARITY



### Classic II S.E.

- High Acoustic Sensitivity
- Patented tunable diaphragm for monitoring low & high frequencies
- Traditional combination chest piece with non chill rim.
- Compact & Durable Design
- Patented Littman soft-sealing eartips.
- Available in 3 colours.



### Classic II Pediatric

- High Acoustic Sensitivity
- Specially designed for pediatric auscultation
- Traditional combination chest piece with non chill rim
- Compact & Durable Design
- Patented loading diaphragm
- Patented Littman soft-sealing eartips.



### Duplex 2.0 Stethoscope

designed for better hearing, comfort and durability.

- Innovative acoustic system with extraordinary auscultation for all frequency ranges.
- Precision double chest-piece made of stainless steel or Aluminum.
- Special membrane for precise acoustics, Ø 44 mm (1.7 in), with novel non-chill rims for improved comfort on the skin.
- Anatomically shaped binaural with internal multiple spring for adjusting the contact pressure.
- Extra-soft, replaceable and pivotable ear-tips for perfect sealing at the ear canal and enhanced wear comfort.
- Total length: 74 cm (29.1 in).
- Weight: 151 g (5.3 oz) stainless steel, 97 g 3.4 oz) aluminum.
- Latex-free.
- Including one pair of replacement ear-ti replacement membrane and a name plate



### Tristar Stethoscope with 3 chest pieces

- Dual Head Stethoscope with 3-in-1 stethoscope
- Double chest-pieces for duplex®, duplex® baby and duplex® neonatal made of aluminum with practical rapid-exchange connector.
- Special membranes with diameters of 48 mm, 36 mm, 28 mm, for first-class acoustics
- Flat and soft non-chill rims for improved adaptation on the skin. Matt chromium-plated binaural with integrated reinforced double-spring
- Optimal sealing of the external auditory canal with soft, replaceable ear-tips with metal screw thread
- Strong Y-tube made of PVC for optimal acoustics to shield against undesired stray sounds
- Latex-free
- Includes two pairs of replacement ear-tips, a replacement membrane and a name plate



Consistent accuracy... every time





# STETHOSCOPES

## ACOUSTIC CLARITY



### Nurses Stethoscope



- This stethoscope offers an extraordinary level of quality at an affordable price.
- Ergonomic handling thanks to the new form: contact piece aluminum without extra flat, smooth edges to slide under the cuff when measuring blood pressure.
- Special membrane, Ø 48 mm, with ring protection against the cold particularly flat and soft to better adapt to the skin.
- Matt chrome Arco adjusted by turning.
- Olivas interchangeable soft with metal screw thread for comfortable seal the ear canal.
- Y-tube made of PVC reinforced to isolate unwanted sounds.
- Total length: 77 cm.
- Latex free.

# DIAGNOSTIC SETS

## Perfect for hospitals and practices



optimum flexibility for hospitals and practices



- The diagnostic station can be individually combined according to requirements and the room situation.
- Innovative construction it is variably extendable to the right and the left.
- The basic ri-former® module is available with one handle and can be supplemented with up to 4 further handle modules.
- Advantages of the ri-former® system can be seen in its versatile combination of options.
- The ri-former® offers the required reliability in hectic everyday hospital and practice life, with its centralized electrical supply.
- Cost-saving and environmentally friendly independence from conventional or rechargeable batteries is thus guaranteed.



### RT - Econom ENT

- Riester uni® and econom® sets are handy examination assistants for ENT and ophthalmology
- Available in optional choice of 3 different illuminations
- Reliable product line for ENT and ophthalmology
- Durable & user-friendly
- Illumination of the examination area with 2.7 V vacuum, HL 2.5 V
- Halogen or xenon illumination XL 3.5 V, similar to daylight
- Choice of sets with exceptional cost-effectiveness



### Laryngoscopes

- Quality laryngoscopes with vacuum illumination convince through their interesting cost effectiveness due to an almost unlimited service life
- Well thought-out design guarantees simple handling in daily use.

Durable & User-Friendly



### uni oto/ophthalmoscope

- Removable magnifying lens with 4-fold magnification can be swivelled to both sides.
- Removable cover glass to insert external instruments.
- Including ear specular with stainless steel fitting, 2,3 and 4mm.
- Available with 2.7 V vacuum, HL 2.5 V halogen or XL 3.5 V xenon lamp, similar to daylight



### e-scope

- State of the art 3.7 V LED illumination and conventional alkaline batteries an almost impossible combination up to now
- The new e-scope® is the perfect blend of leading-edge LED technology, more efficient diagnosis and an environment-friendly energy source
- e-scope® breaks new ground with its world innovation, the IPC (Integrated Power Converter): younger, smarter and greener.

### Tuning Fork



Tuning fork set III  
5 tuning forks, aluminum in plastic case



Tuning fork set II  
8 tuning forks, steel

- The tuning fork sets are well thought-out combinations in an attractive practical wooden or plastic case to perform full hearing tests.
- The most important frequencies are all conveniently to hand.

# MEDICAL LIGHTING

HIGH performance and illumination



## ri-focus LED Headlight

- High performance LED with an improved illumination performance of +40% and a new battery compartment for a fast and easy change of batteries.
- Flexible hinge for a comfortable one-hand use of the LED illumination body
- More efficient diagnosis due to high performance LED with up to 100.000 Lux
- Wireless headband with built-in battery compartment
- Comfortable with a balanced headband and one-hand operation.



## ri-magic HPLED Examination light

- Highly flexible, long arm can be bent in all directions
- Rheostat handles for continuously variable adjustment of light intensity
- Wide-range power supply for 230V/120V
- Available with a choice of plugs to suit the electrical outlets in your country upon request
- Available as mobile, wall and examination table or desk design
- Sturdy mobile base made of fiberglass and chrome plated pole, diameter 54 cm (21.3 in), easy to move due to low friction castors (antistatic castors can be locked)
- Power supply attached to the pole (optional)

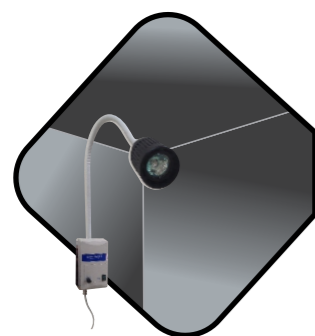

## Examination Light EL-100W (Wall Mount)

- Technical Data: Halogen | Product : Examination Lamp
- Illumination Int (lx) :5000 | Colour Temp (K) : 3000-4000
- Spot Diameter (mm) : 80-150 | Height Adj (mm) : 700
- Lamp Head (V/Hz) : 75 | Power Supply (VA) : 220/50
- Power Input : 50 | Spec Of Bulb (W/V) : 35/12

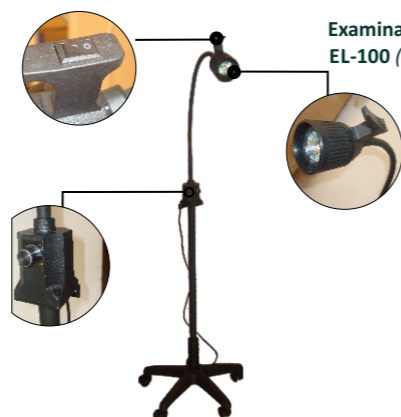

Examination Light EL-100W ( Moveable)

## Examination Light EL-100W (Moveable)

- Technical Data: Halogen | Product : Examination Lamp
- Illumination Int (lx) :5000 | Colour Temp (K) : 3000-4000
- Spot Diameter (mm) : 80-150 | Height Adj (mm) : 700
- Lamp Head (V/Hz) : 75 | Power Supply (VA) : 220/50
- Power Input : 50 | Spec Of Bulb (W/V) : 35/12

# THERMOMETERS

Oral, axillary, rectal & infrared



## Eco Temp (MC 321E)

- Thermometer for oral, axillary or rectal use
- Normal response in 60 seconds
- Water resistant
- With beeper
- Memory for last reading
- Automatic switch-off saves on battery life
- Reading display in Celsius or Fahrenheit



## Omron Flex Temp Smart Thermometer

- Ideal for use for the whole family
- Rounded up for increased comfort
- Reading shown in Celsius or Fahrenheit
- Exchangeable batter



## Omron Thermoscan Ear Thermometer

- 1 Second Quick Measurement
- 9 Sets Memory
- Fever Alarm with Beeper



## Infrared No Touch

- Auto Power Of & Illuminated display
- 3-in-1 temperature measurement | display in F or C
- 25 memory locations
- Contact less temperature measurement with infrared
- Quick 1-second measurement with beep
- Ergonomic design



## T-One

- T-One is a NO-TOUCH infrared thermometer
- Provide quick and accurate body temperatures, 5cms from the patient
- Temperature readings of surfaces and objects can be set by the user
- Size: 4cm in length Weight: 75g
- Comes with a 2 year warranty

# NEBULIZERS

Complete respiratory solution



## CompA.I.R Pro

- Water protected switch
- Energy efficient system
- V.V.T. nebulizer technology
- Convenient holder for Nebulizer Kit
- Handy carry bag
- Handy shaped Nebulizer Chamber
- Easy to attach and detach tube connectors



## Omron Nebulizer

- Low noise
- Fine Mist
- Small particle size
- Light weight



## Compressor Nebulizer

- With Omron V.V.T. (Virtual Valve Technology) nebulizer kit, for efficient delivery of medication without silicon valve.
- Compact, travel convenient (with Battery Pack)
- High nebulization rate ensures optimized treatment duration.
- Leaves minimal residual medication.
- Easy to operate and maintain, with easy-to-clean nebulizer kit without silicon valves.

OMRON

## Eolo Nebulizer



- EOLO is an electrically fed compressor with aerosol therapy atomiser.
- The instrument is designed for easy transport and handling and is recommended for atomizing antibiotics and bronchodilator drugs.

CAMI  
Italian Medical Touch

## AMBU BAGS

Quality manual resuscitator bags



- Complete kit has star lumen oxygen tube, reservoir bag, silicon mask, resuscitator bag and pressure release valve.
- Good recoiling property after pressing during resuscitation.
- 360° rotation of connectors between patient & resuscitation bag
- Made from 100% silicon, autoclavable.
- Non-Sterile.

### Contents per Kit:

- 1 Silicon resuscitator Bag, 1 Silicon Mask.
- Star Lumen tube, 1 Reservoir Bag (PVC).
- Complete in cardboard box

Besmed

AMBU BAGS

# EMERGENCY

LIFE saving on-the-go devices

## ECG Heart Monitor



- Portable single channel ECG Monitor
- Ideal screening for arrhythmia such as Arterial Fibrillation and Self-Monitoring of cardiac events
- Cordless- no need to wear electrodes
- Complete with software allowing easy importing of ECG data to PC, Memory for 300, date & time stamped measurements

OMRON

## Tourniquet



- Sturdy metal pump
- Air release by opening the valve
- Chromium-plated metal manometer with easy-to-read aluminum scale up to 700 mm Hg
- Includes upper arm cuff 57 x 9 cm (22.44 x 3.54 in) and thigh cuff 96 x 13 cm (37.80 x 5.12 in), both with latex-free bladders
- Optional child cuff 38 x 8 cm (14.96 x 3.15 in)
- Washable and disinfectable cuffs
- Complete in cardboard box

Riester



# FAT MONITORS

Live healthier



## BF 306 Body Composition Monitor

- Body Fat and classification
- BMI and classification
- 9-user memory
- Age range 10–80 years
- Up to 199 kg



OMRON

## BF 508 Body Composition Monitor

- Clinically validated
- Body fat and classification
- BMI and classification
- Visceral fat and classification
- 4 user memory
- 8 sensor technology
- Age range 18-80 years

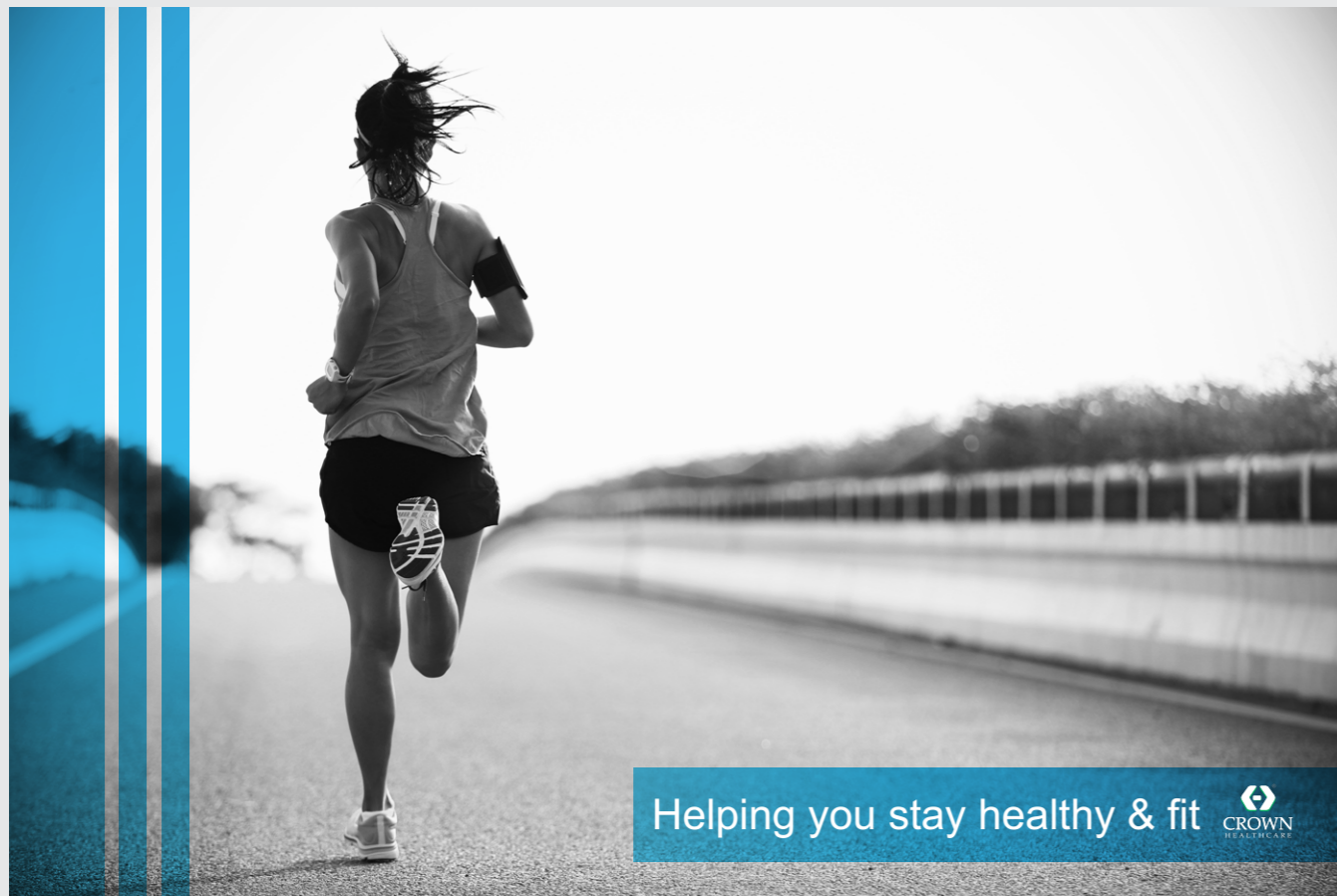

Helping you stay healthy & fit



## MEDICAL SCALES

- Pediatric Scales & Measuring System
- Measuring Stations & Column Scales
- Flat Scales
- Height Measuring Systems
- Multi-functional & Wheelchair Scales
- Specialized Scales
- Seca mBCA



MEDICAL SCALES



# PAEDIATRIC SCALES & MEASURING SYSTEMS

## Mechanical



### Seca 310

**Hanging dial Scale for Infants  
Dial Type 25kg**

Suspension hooks are made of galvanized steel and are extremely durable and safe.

**Capacity:** 15 or 25 kg

**Graduation:** 25 or 50 g

**Dimensions:** (WxHxD) - 220 x 275 x 45 mm

**Weight:** 1.14 kg ; Easy to read due to precision knife edge pointer and large scale with a diameter of 18 cm.



### Seca 312

- Capacity: 5 kg / 11 lbs
- Graduation: 25 g / 1 oz
- Functions: reset-to-zero function
- Optional: set of 5 pieces sling seat secas 410, carrying case secas 411

*The unit offers 3 color indications to easily identify the baby's weight category: 0.0 – 2.0 kg red (severe malnutrition), 2.0 – 2.5 kg yellow (malnutrition), 2.5 – 5.0 kg green (normal weight).*



### Seca 725

**Mechanical baby scales with sliding weights**



- Capacity: 16 kg
- Graduation Weight: 5g
- Functions: Reset-to-zero function



*The reset-to-zero function guarantees reliable determination of net weight by simply deducting the extra weight of padding or diaper.*

## Digital

### Seca 334

**Mobile Electronic Baby Scale  
(with Height Meter)**



- Capacity: 44 lbs / 20 kg
- Graduation Weight: 0,2 oz < 22 lbs > 0,5 oz
- Power supply: Batteries / Optional Power Adaptor
- Functions: kg/lbs switch-over / BMIF / Auto-HOLD / Automatic switch-off / TARE



### Seca 354

**Electronic Baby Scale  
with fine graduation  
also usable as flat scale  
for children**

*The weighing tray can be removed quickly and easily at the touch of a button.*

- Capacity: 20 kg
- Graduation Weight: 10 g
- Weight: 5 lbs / 2,3 kg
- Power supply: Batteries
- 20,7 x 3,1 x 9,8 inch dimensions tray
- Functions: kg/lbs switch-over / BMIF / Auto-HOLD/Automatic switch-off / TARE

## Measuring System

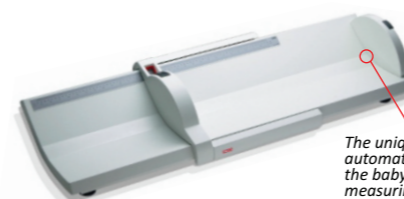

*The unique V-shape automatically places the baby in the right measuring position*

### Seca 416

**Infantometer for measuring babies and toddlers in the hospital**

- Measuring range: 33 - 100 cm / 13 - 39 inch
- Graduation Length: 1 mm / 1/16 inch



### Seca 417

**Light, space saving and stable measuring board also ideal for mobile use**

- Measuring range: 10 - 100 cm / 4 - 39 inch
- Graduation Length: 1 mm / 1/8 inch



### Seca 210

**Mobile measuring mat for babies and toddlers**

- Measuring range: 10 - 99 cm / 4 - 39 inch
- Graduation Length: 5 mm / 1/4 inch
- Functions: Mobile measuring / Wall fastening essential/possible



### Seca 412

**Carry case for measuring board secas 213 and secas 417**

- Measure (W x H x D): 686 x 427 x 56 mm
- Net weight: 650 g

### Seca 211

**Disposable measuring tape for head circumference**



- Precise. Exact results can be read instantly.
- Comprehensive. Measuring range from 5 – 59 cm.
- High-quality. Hygienic disposable measuring tape made of high-quality paper can reduce cross-contamination of germs.

### Seca 212

**Measuring tape for head circumference of babies and toddlers.**



- Hygienic disposable measuring tape of non-stretch Teflon material.
- Double function: head circumference with the front side of the tape and facial symmetry with the rear side.
- Easy-to-read, colour-coded precise results.
- Practical dispenser (content: 15 tapes).
- Scale from 1 to 59 cm

# MEASURING STATIONS & COLUMN SCALES



## Seca 786

**Mechanical column scale with large round dial**

The seca 786 is always ready for use because it needs neither electricity nor batteries. The robust scale determines weight quickly, accurately and conveniently. Every patient can weigh himself effortlessly without assistance.

- Capacity: 150kg
- Graduation (g): 500 g
- Measure (W x H x D): 295 x 910 x 500 mm
- Functions: Reset-to-zero function
- Optional: measuring rod seca 224

The black rubber mat on the platform is robust and easy to clean.

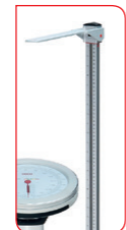

## Seca 755

**Mechanical Column Scales with BMI display**

The separately available measuring rod permits simultaneous weighing and measuring.



It is easy to determine BMI with the color-coded dial.

- Capacity: 350 lbs, 160 kg
- Graduation (g): 500 g, 500 g / 1 lbs, 500 g / 1 lbs
- Functions and Properties: Transport custers, BMI, Reset-to-zero function
- Optional: measuring rod seca 224



Precision for health



## Seca 769

**Electronic Column Scales with BMI Function**

- Capacity: 450 lbs, 200 kg
- Graduation (g): 100 g / 0,2 lbs
- Functions and Properties: TARE, HOLD, BMI, kg/lbs/sts switch-over, Automatic switch-off
- Optional: measuring rod seca 220 or seca 224, power adapter seca 447 switch-mode power adapter seca 400



## Seca 703

**EMR ready column scale with capacity up to 300 kilograms**

- Capacity: 300 kg / 660 lbs
- Graduation: 50 g < 150 kg > 100 g / 0.1 lbs < 330 lbs > 0.2 lbs
- Functions: TARE, pre-TARE, mother/child-function, HOLD, auto-HOLD, BMI, auto-CLEAR, kg/lbs switch-over, damping, automatic switch-of, SEND/PRINT



Precision for health

# FLAT SCALES

## Classic Precision



## SECA-762

**Mechanical personal scale with fine 500g graduation**

The precise design classic has a large clear and well-defined dial. With a large, low-level, non-slip platform and scratch resistant finish it is easy for the patient to step on and weigh.

- Capacity: 150kg, 320 lbs, 150kg/320 lbs
- Graduation: 500 g, 1 lbs, 500 g / 1 lbs, 500 g / 1 lbs
- Functions: Reset-to-zero function



## SECA-813

**Electronic flat scales with very high capacity.**

- Capacity: 440 lbs, 200 kg
- Graduation Weight: 100 g / 0.2 lbs
- Power supply: Batteries
- Functions and Properties: Auto-HOLD, Step-Off, kg/lbs/sts switch-over, Tap-on automatic switch-on, Automatic switch-off



Precision for health



## SECA-874

**Mobile flat scales for mobile use with push buttons and double display**

- Mother/child function for trouble-free weighing of small children.
- Large leveling bases for increased stability.
- Low device weight and battery power for mobile use.
- Double display for readout from different positions.
- Two push buttons for effortless operation with the foot.
- Capacity: 440 lbs / 200 kg
- Graduation Weight: 50 g < 150 kg > 100 g / 0.1 lbs < 330 lbs > 0.2 lbs



## SECA-804

**24 chrome-plated electrodes and BW/BF function.**

- 24 electrodes. For analysis of body fat and body water.
- Automatic user recognition. For fast measuring results.
- Four memories. For practical multi-person use.
- BMI function to determine nutritional status.
- Capacity: 330 lbs, 150 kg
- Graduation Weight: 100 g / 0,2 lbs / 0,2 lbs
- Power supply: Batteries
- Functions: BF / BW-Measurement, Auto-HOLD,
- BMI, kg/lbs/its switch-over, Tap-on automatic switch-on, Automatic switch-of, patient memory,



Precision for health

Non-Slip & Scratch Proof



Safety & Accurate Weighing



# FLAT SCALES

## CLASSIC Precision



### SECA-876

Mechanical personal medi-Scales

- Capacity: 250 kg / 550 lbs
- Graduation: 100 g < 150 kg > 200 g / 0.2 lbs < 330 lbs > 0.5 lbs
- Functions: mother/child-function, kg/lbs switch-over, tap-on automatic switch-on, automatic switch-off
- Optional: stadiometer seca 217 combined with adapter element seca 437, carrying case seca 414 (for combination with stadiometer and adapter element) and seca 415



### SECA-869

Flat scale with cable remote display

- Separate display and operating element with infinitely adjustable tilt angle for convenient use.
- Large, easy-to-read 0.75 inch-high LCD figures.
- BMI function to determine nutritional status.
- Capacity: 550 lbs, 250 kg
- Graduation (g): 100 g < 150 kg > 200 g / 0,2 lbs < 330 lbs > 0,5 lbs / 0,2 lbs < 23 sts > 0,5 lbs
- Functions and Properties: Mobile measuring and weighing, TARE, HOLD, BMI, kg/lbs/sts switch-over, Automatic switch-off
- Optional: stadiometer seca 217 combined with adapter element seca 437, carrying case seca 414 (for combination with stadiometer and adapter element) and seca 415

# HEIGHT MEASURING SYSTEMS



### Seca 217

Mobile Measuring and weighing

- Parts fit together perfectly for transport ease.
  - Spacer for additional stability.
  - Robust platform for secure stance.
  - Adapter element seca 437 for connection to a flat scale.
  - Measuring range in cm: 20 – 205cm
  - Graduation [Measuring Rod]: 1mm, 1mm
- Measure (W x H x D): 328 x 2145 x 574mm



### SECA-222

Mechanical telescopic measuring rod with large measuring range

- Telescopic measuring rod with large measurement range up to 230 cm.
- Extra-broad slide unit.
- Includes heel positioner for ideal three-point measurement.
- Developed for wall installation.
- Results are easy to read even for very tall patients.
- The rod is made of durable aluminum.
- Abrasion-resistant height rod made with a high-quality screen printing process.

# HEIGHT MEASURING SYSTEMS



### Seca 206

Mechanical measuring tape

The space-saving solution with roll-up mechanism. Uncomplicated fixing on wall with just one screw. With the display window in the head piece, it's easy to read the height. The durable tape is made of metal

- Measuring range in cm: 0 - 220 cm
- Graduation [Measuring Rod]: 1 mm
- Functions: Wall-mounting



### Seca 201

Circumference tape

Retractable measuring tape for precise body measurements. Printed scale on side makes results easy-to-read. Convenient one-handed operation -- fasten start of tape to retraction mechanism. Compact and easy to store.

- Measuring range in cm: 0 - 205 cm
- Graduation [Measuring Rod]: 1 mm



### Seca 216

Mechanical measuring rod The measuring station

- Two different measurement ranges.
- Easy read-out.
- Adjustable head positioner.
- Choice of two units of measurement.
- Simple assembly.
- Measuring range: 0-220 cm
- Graduation: 1 mm, 1/



### SECA-213

The measuring stations by seca measure and weigh in a single step

At only 2.4 kg, the seca 213 mobile stadiometer is especially suitable for use in the field but also ideal for doctors' practices and pediatric hospitals.

The measuring rod can be dismantled into several pieces and set up easily and quickly. The spacer keeps the rod straight and stable without any fittings. As the scale is printed along the side of the measuring rod, it is easy to read of the result while measuring, has guaranteeing precise results – up to a height of 205 cm.

- Measuring range in cm: 20 - 205 cm
- Graduation : 1 mm, 1 mm

# Possible Combination

seca869/874/876, seca217, seca 437 and seca 414

The new mobile weighing and measuring system for school children and adults



With the help of the adapter element seca 437, the stadiometer seca 217 can be attached to the flat scales seca 869, seca 874 or seca 876 to make a perfect weighing and measuring system for school children and adults.

The result is two measurements of best quality in just one step. Even though the elements are lightweight and easily assembled, the system is extremely stable and warp-resistant. Almost like a permanent installation.

# SPECIALIZED SCALES

Designed for your requirements



## SECA-491

Calculator With BMI Mode

- Power supply: Batteries
- Functions: BMI / Automatic switch-of



## SECA-856

- Capacity: 11 lbs, 5 kg
- Graduation: 1 g < 3 kg > 2 g / 0,05 oz < 6,6 lbs > 0,1 oz
- Functions: TARE, Pre-TARE, HOLD, kg/lbs switch over, Automatic switch-of

BMI is now as Easy as 123



## SECA-465

- Print speed: 80 mm/sec
- Functions: print-out of height, weight, BMI, resting or total energy expenditure or percentiles for children
- Optional: 5 or 50 rolls of thermal paper seca 485
- Included with printer: SD smart card, power adapter, SD card reader, 1 roll of thermal paper
- System compatible with: all measuring devices & scales in the seca 360° wireless system

# SPECIALIZED SCALES

Designed for your requirements

## seca mBCA 514

Medical Body Composition Analyzer



- Fast and easy assessment of body composition, e.g., fat mass and body water.
- Six modules for varied analysis of measurement data.
- Medically precise, validated against gold standard measurement results.
- Network compatible with seca 360° wireless technology.
- Simple and convenient entry and read-out of results on swiveling touch-screen display.
- Electrodes on handrail give patients a firm stance and ensure reproducible results.
- Integrated scale with a weighing capacity of up to 660 lbs.

### Technical Specification

- Dimensions (WxHxD) 38.43 x 49.25 x 32.6 inch
- Weight 80 lbs
- Display 8.4" Touch-screen display, can be rotated 360°
- Power supply Power adapter
- Voltage 100 V – 240 V
- Power frequency 50 Hz – 60 Hz
- Interfaces seca 360° wireless technology, USB 2.0, Ethernet
- Compatible printers seca 360° wireless, laser printer and inkjet printer via PC software seca analytics 115

## SECA-984

Electronic bed & dialysis scale with equipment trolley

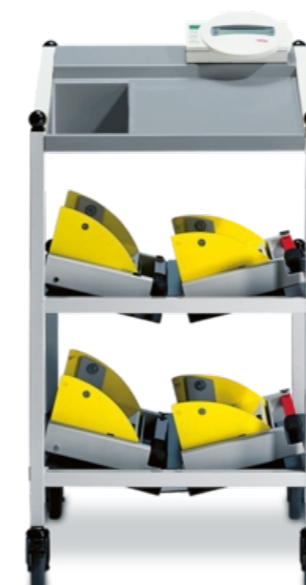

- Capacity: 500 kg / 1,100 lbs
- Max. patient weight: 250 kg / 550 lbs
- Graduation: 100 g < 200 kg > 200 g / 0.2 lbs < 440 lbs > 0.5 lbs
- Functions: TARE, pre-TARE, HOLD, BMI, limit value, kg / lbs switch-over, damping
- Optional: RS232 interface seca 460





## MULTI-FUNCTIONAL WHEELCHAIR SCALES



### seca 954

Wireless chair scale to weigh seated patients

Care and comfort were kept in mind when designing the stable model with a circular steel tube frame. The comfortable seat provides a safe position while the swiveling armrests and adjustable footrests make the chair scale more user friendly. The locking rear wheels ensure that it is safe to sit down and stand up at all times.

- Capacity: 300 kg / 660 lbs
- Graduation: 50 g < 150 kg > 100 g / 0.1 lbs < 330 lbs > 0.2 lbs
- Functions: TARE, pre-TARE, HOLD, auto-HOLD, BMI, auto-CLEAR, kg/lbs switch-over, damping, automatic switch-of, SEND/PRINT. RS232 compatible



### seca 952

Chair scales for weighing while seated

With a capacity of 200 kg and a graduation of 100 grams, the seca 952 fulfills all basic medical standards. Added to that are the typical seca advantages such as fold-up armrests and footrests, secure wheel brakes, an ergonomically shaped seat and smooth rollers, which, together with the ergonomically shaped handle, make it very easy to push the chair scale.

- Capacity: 200 kg / 440 lbs
- Graduation: 100 g / 0.2 lbs
- Functions: TARE, auto-HOLD, kg/lbs switch-over automatic switch-of

## MULTI-FUNCTIONAL HAND RAIL SCALES



### SECA-665

EMR ready electronic wheelchair scale

- Capacity: 790 lbs, 360 kg
- Graduation: 50 g / 0,1 lbs / 0,1 lbs
- Power supply: Rechargeable batteries, Power adapter
- Two ramps included. Easy-to-fold and transport
- Network-capable with seca 360° wireless technology.
- Flat platform with self-lowering ramp.

## MULTI-FUNCTIONAL HAND RAIL SCALES



### SECA-644

Multifunctional handrail scales

Equipped with an extremely low-level, easy-access platform, a stable handrail, and high weight-bearing capacity, this multi-functional scale ensures safe and comfortable weighing of heavy patients.

- Capacity: 800 lbs, 360 kg
- Graduation (g): 50 g / 0,1 lbs / 0,1 lbs
- Power supply: Rechargeable batteries & Power Adapter



## OTHER SCALES

### Paediatric Scales



### Contrex MS20E

Digital Baby Scale

- Display Type: With LCD Display
- Weighing Capacity: 20 Kg (44.09 Lb)
- Technology: Battery operated
- Configuration: Tabletop
- Accuracy: Min.: 5 G (0.18 Oz) Max.: 10 G (0.35 Oz)



### Contrex MS20

Medical Mechanical Baby Scale with Heightometer

- Capacity : 20kg
- Graduation : 500g
- Easy to Clean

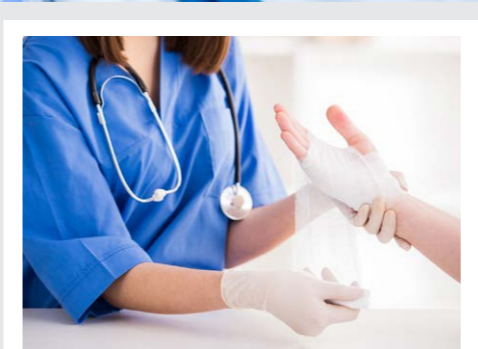

NON PHARMACEUTICAL

- Cotton Dressing
- Sterile Dressing
- Bandage & Plasters
- Gloves
- Face Masks & Surgical Caps
- Tubing & Clamps
- Blood Bags
- Urology
- Sutures
- First Aid Boxes
- Accessories

# OTHER SCALES

## Paediatric Scales

### Baby Scale hanging Type

- Technology: mechanical
- Display type: dial indicating
- Weighing capacity: Min.: 0 kg (0 lb)
- Max.: 25 kg (55.12 lb)
- Accuracy: 100 g (3.53 oz)



### SP-423 Wooden Measuring Board Anthro Board

- Type: Floor Scale
- Power Supply: manual
- Display Type: Indicator



## Measuring Station

### Contrex 120 Health Scale Column SC-120 with Height Meter

- Capacity: 120kg
- Minimum value per division: 0.5kg
- Height range to be measured: 70-190cm



### Contrex 150 Health Scale Column

- Capacity: 150kg
- Minimum value per division: 0.5kg
- Height range to be measured: 85-210cm



## Flat Scales



### Camry Bathroom Scales 9012 62/63

- Mechanical personal scale
- Easy to read
- Weight Capacity: 120kg/260lb
- Graduation: 1kg/2lb



### Digital Scale

- Automatic measurement, just stand on the scale
- Four sensors one at each corner of the device - for accurate measurement
- Safety Glass. 100 g increments in weight.
- Even the smallest changes in your weight can now be displayed
- Measurement in Kg, St and Lb.
- Max Weight 150 kg

# COTTON DRESSING

VALUE & quality you can count on

## Cotton Dressing



Description	Unit	Brand
gauze Rolls 19x15 Mesh 90cm x 50 Y BP Quality 750gm	Roll	Steri Gauze
Gauze Rolls - HQ Quality 36" x 100 Yds BP Quality 1500gm	Roll	Steri Gauze
Gauze Rolls - X ray Detectable 36" x 100 Yds 1500gm	Roll	Steri Gauze

## Gauze Swabs



Description	Unit	Brand
gauze Swabs 2" x 2" Non Sterile	100	Steri Swabs
Gauze Swabs 3" x 3" Non Sterile	100	Steri Swabs
Gauze Swabs 4" x 4" Non Sterile	100	Steri Swabs
Gauze Swabs 2" x 2" Sterile 8 Ply Individual Packs	100	Steri Swabs
Gauze Swabs 3"x 3" Sterile 8 Ply Individual Packs	100	Steri Swabs
Gauze Swabs 4"x 4" Sterile 8 Ply Individual Packs	100	Steri Swabs

## Bandages



Description	Unit	Brand
WOW 1" x 4 yds 19 x 15 Mesh	12	Steri Swabs
WOW 2" x 4 yds 19 x 15 Mesh	12	Steri Swabs
WOW 3" x 4 yds 19 x 15 Mesh	12	Steri Swabs
WOW 4" x 4 yds 19 x 15 Mesh	12	Steri Swabs
WOW 6" x 4 yds 19 x 15 Mesh	12	Steri Swabs

## Bandages



Description	Unit	Brand
abdominal   Laparotomy Swabs 40 x 40 cm with X Ray	25	Steri Swabs
Triangular Bandages 32 x 50 x 48	12	Tri Ban
Sterigras Acetate Chlorhexidine 0.5% (Orange)	10	Steri Gauze P
Steriin Swabs with Para n 10cm x 10cm (Blue)	10	Steri Gauze P
Steritulle Anhydrous Lanolin sulphate dressing (Green)	10	Steri Gauze P

# STERILE DRESSING

DESIGNED for your requirements

## Sterile Dressing



Description	Unit	Brand
sterile Dressing No 7 [Small]	Each	Premium
Sterile Dressing No 8 [Medium]	Each	Premium
Sterile Dressing No 9 [Large]	Each	Premium
Sterile Dressing No 16 [Eye]	Each	Premium

## Medical Tapes



Description	Unit	Brand
autoclave Tape 1/2"-50m	Roll	Autotape
Autoclave Tape 3/4"-50m	Roll	Autotape
Autoclave Tape 1"-50m	Roll	Autotape

## Transparent Surgical Tapes



Description	Unit	Brand
PE Tapes 1" x 10 yds Transpore	Roll	Crownpore
PE Tapes 2" x 10 yds Transpore	Roll	Crownpore

## Soft Surgical Tape



Description	Unit	Brand
Soft Surgical Paper Tapes 1"x 10 yds	Roll	Crownpore
Soft Surgical Paper Tapes 2"x 10 yds	Roll	Crownpore
Sureplast Fabric Plaster 19x65mm	100	Sureplast

# BANDAGES & PLASTERS

Value & quality you can count on

## Crownplast Adhesive Fabric Plaster



Description	Unit	Brand
Zinc Oxide Plasters 1" x 4 yds	Roll	Crownplast
Zinc Oxide Plasters 2" x 4 yds	Roll	Crownplast
Zinc Oxide Plasters 3" x 4 yds	Roll	Crownplast
Zinc Oxide Plasters 4" x 4 yds	Roll	Crownplast

## Medicrepe Bandages



Description	Unit	Brand
Crepe Bandages 2" x 5 yds	Roll	Medicrepe
Crepe Bandages 3" x 5 yds	Roll	Medicrepe
Crepe Bandages 4" x 5 yds	Roll	Medicrepe
Crepe Bandages 6" x 5 yds	Roll	Medicrepe
Plaster of Paris 3" x 2.7 m	Roll	Pop
Plaster of Paris 6" x 2.7	Roll	Pop
Plaster of Paris 8" x 2.7 m	Roll	Pop

## Plaster Of Paris



Description	Unit	Brand
Orthopedic Padding 10 cm x 2.7M	12	Orthopad
Orthopedic Padding 15cm x 2.7 M	12	Orthopad
Orthopedic Casting Tapes 4"	12	Softcast
Orthopedic Casting Tapes 5"	12	Softcast
Orthopedic Casting Tapes 6"	12	Softcast

# GLOVES

DESIGNED for your requirements

## Sterile, Latex, P.E. & Industrial Gloves



Description	Unit	Brand
Gloves Sterile Surgical Lightly Powdered Size 6.5	Roll	Protogloves
Gloves Sterile Surgical Lightly Powdered Size 7.0	Roll	Protogloves
Gloves Sterile Surgical Lightly Powdered Size 7.5		Supermax
Gloves Sterile Surgical Lightly Powdered Size 8.0		Protogloves
Gloves Gynecology Small		Protogloves
Gloves Gynecology Medium		Protogloves
Gloves Gynecology Large		Protogloves
Gloves Latex Examination Powder Free Medium		Supermax
Gloves Latex Examination Powder Free Large		Supermax
Gloves Nitrile Examination Small		Supermax
Gloves Nitrile Examination Medium		Supermax
Gloves Nitrile Examination Large		Supermax
Gloves Plastics Examination Medium		Proto gloves
Gloves Plastics Examination Large	Roll	Proto gloves



Only the best for your family 



# FACE MASKS & SURGICAL MASKS

## Face Masks



Description	Unit	Brand
Face Masks Paper 1 Ply Elastic	100	Protomat
Face Masks Paper 2 Ply Elastic	100	Protomat
Face Masks Theatre 2 ply Tie On	50	Protomat
Face Masks Theatre 3 ply Tie On	50	Protomat

## Nurse's & Doctor's Caps



Description	Unit	Brand
Nurses Caps Green	100	Protomat
Doctors/Surgeons Caps Blue	100	Protomat
Disposable Shoe Covers	Pair	Protomat

## Cannulas With Wings & Injection Port



Description	Unit	Brand
Cannula 16   18   20   22g Polyton 100's	100	Polyton
Cannula 24g [Pediatric]	100	Polyton

# TUBINGS & CLAMPS

DESIGNED for your requirements

## Rye Tube, Scalp Vein Set, IV Set & Infant Feeding Tubes



Description	Unit	Brand
IV Giving Sets Model 001	Piece	Angletouch
Measured Volume Infusion Sets [Soluset]	Piece	Angletouch
Blood Giving Sets With Vent	Piece	Angletouch
Cord Clamps Umbilical - Sterile Blue/White	Piece	Angletouch
Suction Catheters Fg 4   5   6   7   10   12	Piece	Angletouch
Suction Catheters Fg 14   16   18   20	Piece	Angletouch
Feeding Tubes Fg 4   5   6   8   10	Piece	Angletouch
Ryles Tubes Fg 10   12   14	Piece	Angletouch
Ryles Tubes Fg 16   18   20	Piece	Angletouch
Mucus Extractor	Piece	Angletouch
Nelathon Catheters Fg 8   10   12   14   16   18	Piece	Angletouch

## Needles & Scalp Vein Sets



Description	Unit	Brand
disposable Needles 19g   25 g	100	Fino-Ject
Disposable Needles 21g   23g	100	Fino-Ject
Scalp Vein Sets 19g   25g	100	Scalpvein
Scalp Vein Sets 21g   23g	100	Scalpvein

# TUBINGS & CLAMPS

DESIGNED for your requirements

## Blood Bags



Description	Unit	Brand
Blood Bags Single 450 cc	-	Polymed
Blood Bags Single 250 cc	-	Polymed



Products designed around safety 

# UROLOGY DISPOSABLES

Designed for your requirements

## Folley Catheter, Urine Bags & Urindom

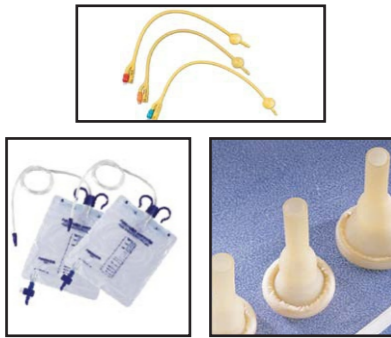

Description	Unit	Brand
Foleys Catheters 2 way 6 / 8 / 10g	Piece	Folicath
Foleys Catheters 2 way 12 / 14 / 16 / 18 / 20 / 22 / 24 / 26g	Piece	Folicath
Foleys Catheters 3 Way 16 / 18 / 20 / 22 / 24 / 26g	Piece	Folicath
Uridoms Small	Piece	Uridom
Uridoms Medium	Piece	Uridom
Uridoms Large	Piece	Uridom
Urine Bag with Outlet	Piece	Uridom
Colostomy Bags Small 20   30   45 mm	Piece	Colobag

## Speciality Surgical Disposables



Description	Unit	Brand
Closed Wound Suction Unit 800ml [Fg 14,16 and18]	Piece	Angletouch
Underwater Seal Drainage Bottle	Piece	Polymed
VP shunt Charbra Type Regular SH202	Piece	Surgiwear
Hemilich Thoracic Valve Labociam	Piece	Labociam FR
Thoracic Catheters [Without Troacar]	Piece	Polymed
Thoracic Catheters [With Troacar]	Piece	Polygon

## Anaesthesia & Oxygen Disposables

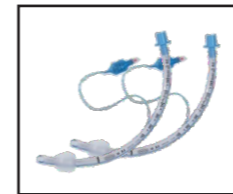

Description	Brand
ET Tubes Clear Cufed 5.0 5.5 6.0 6.5 7.0 7.5 8.0 8.5 9.0	Endotube
Spinal Needle	Fino-Ject
Anesthesia Filters	Criticare
Anesthesia Circuits	Criticare
Anesthesia Rebreathing Bags	Criticare
Anesthesia Masks	Criticare
Anesthesia Masks	Criticare
Oxygen Nasal Cannulas Adult	Oxytube
Oxygen Nasal Cannulas Child	Oxytube
Oxygen Nasal Cannulas Infant	Oxytube
Oxygen Mask Adult with Tubings	Oxymask
Oxygen Mask Adult with Tubings & Non Rebreathing Bag	Oxymask
Oxygen Mask Adult with Tubings Multivent	Oxymask
Oxygen Mask Pediatric with Tubings Oxymask	Oxymask
Oxygen Mask Pediatric with Tubings & Non Rebreathing Bag	Oxymask
Oxygen Mask Pediatric with Tubings Multivent	Oxymask
Oxygen Nebulizer Mask Adult	Oxymask
Oxygen Nebulizer Mask Pediatric	Oxymask



For all your cuts, breaks and bruises 



Breathe easy with... 

# SUTURES

DESIGNED for your requirements

## Premium Healthcare Sutures

Premium Healthcare is a brand of quality surgical sutures suitable for all branches of surgery including cardiovascular surgery, microsurgery and ophthalmology. Our comprehensive range of absorbable & non-absorbable sutures is summarized in the chart below shown:

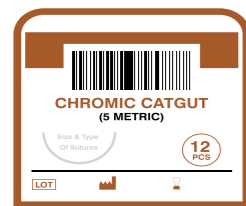

### Chromic Surgical Catgut

**Monofilament:**  
For smooth tissue passage, tie down & knot security

**natural:**  
Produced from purified animal intestines (beef or sheep)

**absorbable:**  
By enzymatic digestion. Complete from 90 days

**Chromic:**  
Treated to provide longer tensile strength retention than plain catgut

**Tensile Strength:**  
Strength retention for at least 28 days

**Color:**  
Tan

**Monofilament:**  
For smooth tissue passage, tie down & knot security

**Range:**  
Gauge sizes 6/0 to 3 (USP) Supplied as needled sutures & ligatures.

**Sterilization:**  
By Irradiation.

**Packaging:**  
In a conditioning fluid containing isopropanol and water.

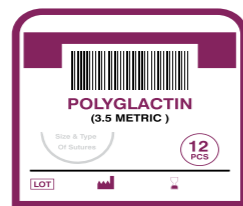

### Polyglactin

**Monofilament:**  
For easy handling & secure knot tying.

**Natural:**  
For minimal tissue reaction

**Absorbable:**  
For hydrolysis. complete between 56 & 70 days predictable & reliable

**Tensile Strength:**  
High initial strength & Strength retention for Upto 28 days

**Color:**  
Violet & Undyed

**Range:**  
Gauge sizes 8/0 to 2 (U.S.P) supplied as need led sutures & ligatures

**Sterilization:**  
Ethylene oxide

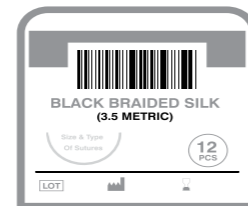

### Braided Silk

**Monofilament:**  
Good knot pull tensile strength with high knot holding security

**Natural:**  
Produced from purified animal intestines (beef or sheep)

**Tensile Strength:**  
The tensile strength will keep long enough for the healing of trauma, without ductility

**Color:**  
Black

**Sterilization:**  
Cr-60 Radiation

**Packaging:**  
Silk thread is serum-proof and water-repellent



### Monoil Nylon

**Monofilament:**  
For smooth tissue passage, tie down & knot security

**natural:**  
Produced from purified animal intestines (beef or sheep)

**Absorbable:**  
Smooth surface will not support bacteria growth.

Description	Unit	Brand
Plain Catgut	12	Polygut
Chromic Catgut	12	Chromisorb
Silky Sutures	12	Sikot
Nylon Sutures	12	Monolyn
Polyglactin	12	Polycryl
Suture Needles Round Bodies - Small   Medium   Large	12	GSTC
Suture Needles Reverse Cutting - Small   Medium   Large	12	GSTC
Suture Needles Straight RB Bodies - Small   Medium   Large	12	GSTC
Suture Needles Straight RC Bodies - Small   Medium   Large	12	GSTC

High Quality Sutures

# SURGICAL & SKIN GRAFTING BLADES

## Surgical Blades



Description	Unit	Brand
Surgical Blades 10/11/12/15G 100's Surgiblade	100	Surgiblade
Surgical Blades 20/21/23/24 100's Surgiblade	100	Surgiblade
Surgical Scalper Plastic Holder Blade	10	Surgiblade

## Caustic Pencils



Description	Unit	Brand
caustic Pencil 40%	100	Bray UK
Caustic Pencil 95%	100	Bray UK



Designed precision

# FIRST AID KITS

Fully equipped to international spec

## First Aid Kits





Description	Size
first Aid Boxes	Small
First Aid Boxes	Medium
First Aid Boxes	Large
First Aid Boxes	Wall Type

# ACCESSORIES & MORE

## ID Tags, Prescription Bags and much more...









Description	UNIT	BRANDS
IDENTITY Band Adult - assorted colours (B,P,W)	100	Small
Identity Band Child - assorted colours (B,P,W)	100	Medium
Prescription Medicine Bags	1000	Large
Clinical Thermometer C + F MEDEX		MEDEX
Wooden Tongue Depressors Checkup		Checkup
Colostomy Bags Small 20/30/40mm MEDEX		MEDEX
Hot Water Bottle 2 litre I sided Ribbed MEDEX		MEDEX
VP Shunt		MEDEX



## PHARMACEUTICAL

- Crown Brands
- Healthcare Pharmaceuticals Ltd
- Brookes Pharmaceuticals Ltd
- Apoorv Nutra Pharm PVT Ltd
- S.Kant Healthcare Ltd
- Aculife Healthcare





# PHARMACEUTICAL BRANDS & HIGH GENERICS

## Crown Healthcare Prescription Pharmaceuticals



Brand Name	Product Name	Volume	Form
Tinifred	Tinidazole Tablets 500g	4	Tablets
Fredluco	Fluconazole Capsules 150mg	1	Tablets
Vofax	Levofloxacin Tablets 500mg	10	Tablets
Azifred	Azithromycin for Oral Suspension USP 200mg/5ml	1	Liquid
Frambi	Secnidazole Tablets 1gm	2	Tablets
Aclofre Tablets	Aceclofenac 100mg Tabs	30	Tablets
Aclofre P	Aceclofenac 100mg & Paracetamol	30	Tablets
Azifred DS	Azithromycin for Oral Suspension USP 200 mg/5 ml 15ml	1	Liquid
Benzapene 2.4	Benzathine Penicillin for injection 2.4 mega	Vial	Injectable
Benzapene One	Benzympenicillin Sodium for injection 1 mega	Vial	Injectable
Clarifred Tablets	Clarithromycin 500mg	10	Tablets
Diclofenac	Sodium Injection 75mg/3ml	Ampoule	Injectable
Drepene 6.3.3	Triple Penicillin 6.3.3 for injection 1.2 mega	Vial	Injectable
Esofred 20	Esomeprazole Capsules 20mg	30	Tablets
Esofred 40	Esomeprazole 40mg	30	Tablets
Evagra Tablets	Sildenafil 100mg	4	Tablets
Evagra Tablets	Sildenafil 50mg	4	Tablets
Finemox CV	Amoxyclav 625mg	10	Tablets
Finemox CV 228.5	Amoxyclav 625mg	100ml	Liquid
Finemox CV 228.5 Susp	Amoxyclav 625mg	70ml	Liquid
Finemox CV 312.5 Susp 100ml	Amoxyclav 625mg	100ml	Liquid
Finemox CV 625mg	Amoxyclav 625mg	10	Tablets
Gentamycin	Sulphate Injection 80mg/2ml	Ampoule	Injectable
Penazone	Procaine Penicillin Fortified for injection 4 mega	Ampoule	Injectable
Quinine Dihydrochloride	600mg/2ml injection	Ampoule	Injectable
Strepto One	Streptomycin Sulfate for injection 1g	Vial	Injectable

Tablet, Liquids & Injectables

## Healthcare Pharmaceuticals



Alcet 5mg Tabs  
Levocetirizine 5mg



Aeron 10mg Tabs  
Montelukast 10mg



Candini 50mg Caps  
Fluconazole 50mg  
Candini 50mg Caps  
Fluconazole 150mg



Cevion Efervescent Tabs  
Vitamin C 1000mg Orange  
Cevion Efervescent Tabs  
Vitamin C 1000mg Lemon



Furotil 250mg Tabs  
Cefuroxime 250mg  
Furotil 500mg Tabs  
Cefuroxime 500mg



Rozith 250mg Tabs  
Azithromycin 250mg  
Rozith 500mg Tabs  
Azithromycin 500mg



Sante Efervescent Tabs  
Vitamin C 500mg + Calcium 1.3g Orange  
Sante Efervescent Tabs  
Vitamin C 500mg + Calcium 1.3g Lemon



Sergel 20mg Caps  
Esomeprazole 20mg  
Sergel 40mg Caps  
Esomeprazole 40mg  
Sergel 40mg Injection  
Esomeprazole 40mg/5ml



**minoxin**<sup>®</sup>  
(minoxidil)

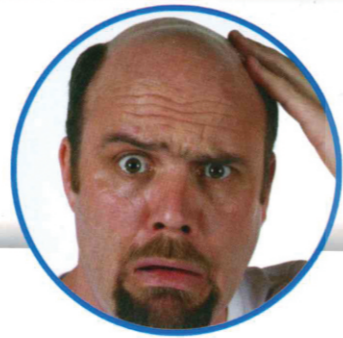

**Minoxin<sup>®</sup> 2% & 5%**

**Minoxin<sup>®</sup> PLUS Solution** (Minoxidil 5%) is safe and effective treatment for men with Androgenetic Alopecia (AGA) and well tolerated over a period of 52 weeks.<sup>1</sup>

MINOXIDIL 5% (**Minoxin<sup>®</sup> PLUS Solution**) was clearly superior to MINOXIDIL 2% and placebo in increasing hair growth and well tolerated in male patients.

Men who used MINOXIDIL 5% (**Minoxin<sup>®</sup> PLUS Solution**) also had an earlier response as compared to those who used MINOXIDIL 2% Topical Solution.<sup>2</sup>

1. J. AM Acad Dermatol. 2007 Nov;57(5):767-74

2. J. AM Acad Dermatol. 2002 Sep;47(3):377-85

**MALE PATTERN BALDNESS AND THINNING OF HAIR IN FEMALE**



## PHARMACEUTICAL BRANDS & HIGH GENERICS

### BROOKES PHARMACEUTICALS LIMITED

Brand Name	Product Name	Volume	Form
GEN LEVO 500MG TABS	Levofloxacin 500mg	10	Tablets
GEN LEVO I.V. INFUSION 500MG	Levofloxacin Infusion	100ml	Liquid
MINOXIN SOLUTION 2%	Minoxidil	60ml	Liquid
MINOXIN SOLUTION 5%	Minoxidil	60ml	Liquid



### APOORV NUTRA PHARM PVT LTD

Brand Name	Product Name	Volume	Form
Apopemem 500mg	Meropenem 500mg	Vials	Injection
Apopemem 1g Injection	Meropenem 1g	Vials	Injection
Apotaz-P 2.25g Injection	Piperacillin & Tazobactam	Vials	Injection
Apotaz-P 4.5g Injection	Piperacillin & Tazobactam	Vials	Injection
Cilapen 500mg	Imipenem & Cilastatin	Vials	Injection



### S. KANT HEALTHCARE LIMITED

Brand Name	Product Name	Volume	Form
Diclokant Gel	Diclofenac Gel	20g	Gel
Cirpokant 500 mg	Ciproloxacin Tabs	10x10	Tabs
Lartem Tabs	Astemether 20mg / Lume-fantrine 120mg	24	Tabs
Mygra 100mg	Sildenafil Citrate Tabs	4	Tabs
Omesk Caps	Omeprazole 20mg	10x10	Tabs
Silverkant Tube	Silver Sulfadiazine 1%	15g	Cream
Silverkant Tube	Silver Sulfadiazine 1%	100g	Cream
Silverkant Tube	Silver Sulfadiazine 1%	250g	Cream
Skderm Tube	Betamethasone + Clotrimazole + Gentamycin	30g	Cream
VitmarKs	Multivitamin Syrup	100ml	Liquid



# PHARMACEUTICAL BRANDS & HIGH GENERICS

## Aculife Healthcare nirlife



Brand Name	Product Name	Volume	Form
DNS	Dextrose 5% with normal saline	500ml	IV Fusion
DNS	Dextrose 5% with normal saline	1000ml	IV Fusion
NS	Normal Saline	500ml	IV Fusion
NS	Normal Saline	1000ml	IV Fusion
D5	Dextrose 5%	500ml	IV Fusion
D50	Dextrose 50%	100ml	IV Fusion
RL	Hartsman's Solution	500ml	IV Fusion
RL	Hartsman's Solution	1000ml	IV Fusion
SWFI	Sterilized Water for Injection	10ml	IV Fusion
SWFI	Sterilized Water for Injection	500ml	IV Fusion
KETANIR	Katamine Injection	10ml	Apoule
Nirmet	Metronidazole Infusion	100ml	IV Fusion
Nirixone 1g	Ceftriaxone Injection 1%	20ml	IV Fusion
NIRPID 20%	IV Fat Emulsion 20%	500ml	IV Fusion
NIRMIN 5-S	IV Amino Acids	500ml	IV Fusion
NIRFOL 1%	Propofol Injection 1%	20ml	IV Fusion
NIRCIP	Ciproloxacin Infusion	100ml	IV Fusion
Nirliv Inj	Levofloxacin Infusion	100ml	IV Fusion
Nirpid 10%	IV Fat Emulsion 10%	500ml	IV Fusion



Quality medication and pharmaceuticals



# B|Braun nutrition



Item No.	Product Description
PH-BB0010	Propofol Lipuro 1%
PH-BB0020	Gelofusion Gel 500ml
PH-BB0100	Water For Injection BP (10ml)
PH-BB1000	Nutricomp Standard fibre D (Diabetes) - 500ml
PH-BB1005	Nutricomp Peptide - 500ml
PH-BB1010	Nutricomp Glutamine Plus - 500ml
PH-BB1015	Nutricomp Peptide - 500ml (Polyethylene bag)
PH-BB1016	Nutricomp Peptide - 500ml (Plastic Bottle)
PH-BB1020	Nutricomp Glutamine - 500ml
PH-BB1030	Nutricomp Drink D (DIABETES) Vanilla 200ml
PH-BB1035	Nutricomp Drink Plus, Banana 200ml
PH-BB1040	Nutricomp Drink Plus, fibre, Vanilla 200ml
PH-BB1050	Nutricomp Drink Renal (2kcal), Vanila 200ml
PH-BB1060	Nutricomp Soup Vegetables 200ml
PH-BB1070	Nutricomp Standard - 500ml
PH-BB1080	Nutricomp Standard Fibre, 500ml
PH-BB1090	Nutricomp Energy HP Neutral - 500ml
PH-BB1100	Nutricomp Standard Fibre D (Diabetes) - 500ml
PH-BB1110	Nutricomp HP fibre - 500ml
PH-BB1120	Nutrifix Universal Adapter HF (feeding tube)
PH-BB1121	Enteroport Plus Set Universal Adapter (Feeding tube)
PH-BB1130	Nutrifix 2500ml (feeding bag)
PH-BB1140	Nutricomp Hepa 500ml chocolate
PH-BB1150	Nutricomp Drink Plus, Strawberry 200ml
PH-BB1160	Enterofix 1000ml Storage/Empty Bag
PH-BB3000	Nutriflex Special 1000ml (2 chamber bag)
PH-BB3010	Nutriflex Special 1500ml (2 chamber bag)
PH-BB3020	Nutriflex Lipid Special 625ml (3 chamber bag)
PH-BB3030	Nutriflex Lipid Special 1250ml (3 chamber bag)
PH-BB3040	Nutriflex Lipid Special 1875ml (3 chamber bag)
PH-BB3050	Nutriflex Lipid Peri (peripheral) 1250ml (3chamber bag)
PH-BB3060	Aminoplasmal Hepa 10% - 500ml
PH-BB3070	Lipofundin MCT/LCT 10% 500ml
PH-BB3080	Lipofundin MCT/LCT 20% 500ml



# CLEANING & DISINFECTION



CODE	PRODUCT DESCRIPTION
<b>AIRBORNE DISINFECTANT</b>	
ANI020	<b>ASEPTANIOS AD 5 Litres</b> Qualitative Composition : Stabilized Dolution of Peracetic Acid (+/- 1200 ppm) and Hydrogen Peroxide.
<b>CLEANING AND DISINFECTION FOR FLOORS AND SURFACES</b>	
ANI002	<b>SURFANIOS 5 Litres</b> Qualitative Composition : Amino acid Hydrochloride, Didecylmethylammonium Chloride, Ca2+, Mg2+ Ions Chelators, Non Ionic Detergent, Colouring, Fragrance.
ANI037	<b>SURFA'SAFE PREMIUM x 750ml</b> Qualitative Composition : Didecylmethylammonium Chloride.
ANI	<b>ANIOSEPT TABZ 2.5%</b> Qualitative Composition : Troclosene Sodium, dihydrate
<b>CLEANING AND DECONTAMINATION OF INSTRUMENTS AND ENDOSCOPES</b>	
ANI027	<b>ANIOS'CLEAN EXCEL D 5 Litres</b> Qualitative composition: didecylmethylammonium chloride, chlorhexidine digluconate, non-ionic and amphoteric surfactants, fragrance colouring and excipients
ANI038	<b>ANIOSYME X3 1 Litres</b> Qualitative Composition: Quaternary ammonium propionate, chlorhexidine digluconate, non-ionic surfactants, enzyme complexes (protease, lipase and amylase), perfume, colourant excipients.
ANI022	<b>ANIOSYME SYNERGY 5, 5 Litres</b> Qualitative Composition: Non Ionic and Anionic Surfactants , Sequestering Agent , Stabilising agents, Enzymatic Complex, Excipients.
<b>RINSING AND RESTORING AGENTS.</b>	
ANI	<b>ANIOS R444 1 Litre</b> Qualitative composition: Phosphoric acid, non-ionic surfactant, excipients
ANI	<b>ANIOS LUBE 1 Litre</b> Qualitative composition: Non-ionic surfactants, lubricating agent, preservative agent
ANI	<b>ANIOS RDA 5 Litres</b> Qualitative Composition: Combination Of Non-ionic And Anionic Surfactants In An Acid Medium.
<b>COLD STERILIZATION OF INSTRUMENTS AND ENDOSCOPES</b>	
ANI005	<b>OPASTER 5 Ltrs (Ready To Use)</b> Qualitative Composition : D'ortho-phtalaldehyde (OPA), Buffer, Colouring, Fragrance.
ANI013	<b>STERANIOS 2% NG x 5 Ltrs (Perfumed Ready To Use)</b> Qualitative Composition : Glutaraldehyde solutions (2%), buffered at pH 6, in the presence of a Surface Acting Catalyst, Colouring and Excipients
<b>DISINFECTION OF SKIN / DELIMITATION OF SURGICAL FIELD HAND HYGIENE</b>	
ANI044	<b>ANIOSGEL 800 75ml</b> Qualitative composition : Ethanol (800mg/g) – Contains Thickening, Moisturizing and Emmolient Agents)
ANI068	<b>ANIOSGEL 800 500ml WITH PUMP</b> Qualitative composition: Ethanol (800mg/g) – Contains Thickening, Moisturizing and Emmolient Agents)
ANI071	<b>ANIOSGEL 800 1L WITH PUMP</b> Qualitative composition: Ethanol (800mg/g) – Contains Thickening, Moisturizing and Emmolient Agents)
ANI014	<b>DERMANIOS SCRUB 4% (Antiseptic Soap) x 1 Ltr</b> Qualitative Composition : Chlorhexidine Digluconate



Cleaning and pre-disinfectant of instruments

55-62

## INFANT & MATERNAL

- Fetal Doppler
- Suction Machines
- Vacuum Extractors
- Fetal Monitor
- Incubators
- Infant Warmers & Resuscitator
- Phototherapy Unit
- Colposcopes



INFANT & MATERNAL

# FETAL DOPPLER

MEETING your obstetric requirements



**sonicaid™**

## SONICAID

### Outputs

- Loudspeaker 350mW rms typical Headset
- 10mW total (32 Omega stereo headset)

### Fetal Health Rate

- Display 3 digit FHR, Pulse/Signal quality
- Battery Low
- Accuracy <+ 2 bpm over 100-180 bpm

Unique design  
Easy to use  
Water proof probe as standard  
Fetal Heart Rate Display

## Sd3 Fetal doppler / pocket / with heart rate monitor

**EDAN**



With excellent sensitivity, complete interchangeability and high durability, SD3 series Ultrasonic Pocket Doppler are ideal for routine fetal heart rate detection by the clinicians. Moreover, the versatile, compact and portable SD3 Vascular Doppler is ideal for clinicians to do quick vascular detection.

- Plug-and-play
- Compact design with easy one-hand operation
- Bright LED screen with real-time FHR display
- 2 MHz probe with deep penetration for later pregnancy and larger patients
- 3 MHz probe detects fetal heart beat as early as 9 weeks
- 4/5/8MHz probe for blood flow detection
- Real-time monitoring for daily use
- Record & play with audio playback and numeric display
- Built-in Li-ion rechargeable battery ensures long working time
- Unique charger stand design

## SonoTrax Series Ultrasonic Pocket Doppler

**SonoTrax**



SonoTrax Series Ultrasonic Pocket Doppler provides caregivers with the most cost effective solution to meet the routine obstetric and vascular requirements.

- Easy to use
- Compact design
- Interchangeable waterproof probe
- Built-in audio recorder
- Large backlight LCD display
- Accurate FHR detection with high-fidelity sound effect
- Support 2MHz, 3MHz, 4MHz, 5MHz, 8MHz waterproof probes
- Auto, Average and Manual modes
- Built-in rechargeable battery
- Automatic power-off to save power



## Pinard Aluminum & Plastic Foetoscope

- Pinard Fetal Stethoscopes
- A Professional Product
- High Quality

# Vacuum Extractors

Safe and secure extraction deceives



**Vacuum Extractor original Malstrom Type**



**Vacuum Extractor original Bird Type**



**Vacuum Extractor Swedish Type**



**Vacuum Extractor Silicon Cup 50/60mm**



# FETAL DOPPLER

Meeting your obstetric requirements

## F9 Express Foetal & Maternal Monitor

EDAN



- 30cm high-resolution, colour TFT-LCD screen
- 12-crystal broad beam waterproof FHR transducer
- Touch screen provides great ease of use
- Foetal and maternal monitoring parameters both available
- 60 hours waveform storage and playback
- Three monitoring interfaces (Foetal/Foetal & Maternal/Maternal)
- Flat surface design and waterproof TOCO transducer
- Built-in long life thermal printer
- Compatible with 150/152 mm universal recording paper
- Compatible with American/International standard recording paper
- Signals Overlap Verification to separate twins FHR
- Fast printing of stored traces
- Insight software for real-time and offline data transmission to PC
- DECG & IUP parameters optional
- Built-in rechargeable battery
- Professional CTG analysis system
- 500 NIBP records and 1440 maternal parameters lists playback
- Continuous post-delivery monitoring with maternal parameters
- Optional Telemetry Transducer System Standard Configuration: Twins FHR, TOCO, FM, AFM, MECCG, HR/PR, NIBP, SpO2, TEMP, Li-ion Battery, Touch Screen.
- Optional Configuration: DECG & IUP, Foetal Stimulator, Telemetry Transducer System

## Foetal Twins Monitor

EDAN



- Foetal Monitor, with its brand new design, crisp color screen and enhanced functionality, addresses the needs of obstetrical departments in offices, clinics and hospitals.
- F3 offers an extensive set of external foetal care monitoring parameters such as FHR, TOCO as well as foetal movement. Efficiently designed, compact and easy to use.
- 5.6" Color LCD
  - Lightweight and portable design
  - Display waveforms and Digital Simultaneously
  - Support US/International Standard 150/152mm width recording paper TWINS FHR, TOCO, AFM, Fetal movement
  - High Resolution and long life Built-in Thermal Printer
  - Fast Print Speed (history data): Up to 15mm/sec
  - Portable Trolley
  - Lithium on Battery

# COLPOSCOPY

Examine with clarity

## Eden c3/c6 video colposcope

EDAN



With its bright LED cold lighting system, high resolution camera and electronic green filter, the video colposcope realizes full-screen display of the precise cervical examination, which is very important to the gynaecologist.

- Electronic green filter enhances vascular image display without compromise of illumination
- Advanced and fast auto-focusing system ensures clear image
- Acetic acid and iodine reaction test timer to capture the right and precise image
- LED cold lighting system realizes real view of tissue
- Real-time display of magnification
- Powerful image display and data management software 1X-28X magnification range—C3 1X-36X magnification range—C6
- New innovation – R-way™ Evaluation Program, that supports cervical disease diagnosis

# INCUBATORS

TEMPERATURE & climate controlled

## A-100 Baby Incubator



- With box temperature control mode;
- Set the temperature and the inside temperature split-screen display;
- Dual CPU control system, independent over-temperature cut-of device of the triple over-temperature protection;
- Natural air duct humidification;
- Products with self-test function, a variety of fault alarm;
- The front panel has a function of temperature can be corrected
- Baby compartment closed with automatic locking function;
- A temperature data storage function; With RS -232 interface.

# INCUBATORS

TEMPERATURE & climate controlled



## A-200 Baby Incubator

- Mild skin temperature with two kinds of temperature control;
- The set temperature, the inside temperature, skin temperature split-screen display;
- Dual CPU control system, independent over-temperature cut-of device of the triple over-temperature protection;
- Natural air duct humidification;
- Cots step-less adjustable lift function;
- Products with self-test function, a variety of fault alarm;
- Spiral duct and AC and DC motors produce centrifugal supercharger, the overall aluminum tank;
- The front panel has a function of temperature can be corrected;
- Skin temperature sensor has come of protection function;
- Baby compartment closed with automatic locking function;
- A temperature data storage function; With oxygen input interface; With RS-232 interface.

### Basic Configuration:

- Host (including baby cabin, chassis, controller), infusion stand & trays, racks, skin temperature sensor.

### Optional Configuration:

- >37 c Temperature setting mode, lift the cabinet, feet, weighing device, can use low-noise DC motor
- Optional Configuration: DECG & IUP, Foetal Stimulator, Telemetry Transducer System



## A-400 Baby Incubator

- Air mode and baby mode servo-controlled by a microcomputer.
- Humidity concentration control system.
- Oxygen concentration control system.
- Set temperature, air temperature, baby temperature, humidity concentration and Oxygen concentration are displayed separately.
- >37 C temperature set function.
- Inclination of the bassinet is adjustable.
- Multiple failure alarm indications.
- Embedded integrated sensor box and drawer-type water reservoir;
- Double wall hood, automatic air circulation device.
- RS-232 connector.
- Use DC motor with low noise.
- Optional configuration: Fixed neonate bilirubin phototherapy equipment, Vertical Height Adjustment cabinet (VHA stand).
- Weighing system.

# INFANT WARMERS & RESUSCITATOR



## Infant Warmer IR 200

- With a warm, hand control, skin temperature three kinds of temperature control mode.
- Set the temperature and skin temperature split screen display;
- Dual CPU control system, independent over-temperature cut-of device of the triple over-temperature protection
- Radiation box horizontal angle and the tilt angle adjustable crib;
- Crib around the plexiglass base can be lipped down or removed;
- Products with self-test function, a variety of fault alarm;
- The front panel has a function of temperature and can be corrected;
- Skin temperature sensor has come of protection function;
- Cots can be placed under X-ray film cassette;
- A temperature data storage function;
- With APGAR score timing function;
- With RS-232 interface.

### Basic Configuration:

- By the radiation box, control device, cribs, racks, skin temperature sensor, infusion stand, tray.



## Resuscitator IR 300

- With a warm, hand control, skin temperature three kinds of temperature control modes;
- Set the temperature and skin temperature split screen display;
- Double CPU control system, independent over-temperature cut-of device of the triple over-temperature protection;
- Radiation box horizontal angle and the tilt angle adjustable crib;
- Crib around the plexiglass base can be lipped down or removed;
- Products with self-test function, a variety of fault alarm;
- The front panel has a function of temperature can be corrected;
- Skin temperature sensor has come of protection function;
- Cots can be placed under the X-ray film cassette;
- A temperature data storage function;
- APGAR score with timing function;
- With RS-232 interface;
- With jaundice treatment device;
- With oxygen equipment, low pressure suction apparatus;

### Basic Configuration:

- By the radiation box, control device, cribs, racks, skin temperature sensor, infusion stand, tray, jaundice, therapy apparatus, oxygen equipment, low pressure suction device. Therapy apparatus, oxygen equipment, low pressure suction device.

# PHOTOTHERAPY UNITS

## MOBILE & fixed units



### AS20

- Mobile and fixed models; fixed model is specially mounted on our company's infant incubator;
- Blue fluorescent lamp
- Timer to count phototherapy time;
- Angle of lamp module can be adjusted (for mobile model);
- Height of lamp module can be adjusted (for mobile model);
- Wheels can be locked (for mobile model).



### AS20L

- Mobile and fixed models; fixed model is special mounted on our company's infant incubator;
- LED Bulb;
- Timer to count phototherapy time;
- Angle of lamp module can be adjusted (for mobile model);
- Height of lamp module can be adjusted (for mobile model);
- Wheels can be locked (for mobile model).



You babies safety comes first 



### HOSPITAL FURNITURE

- Hospital Beds
- Home Care Beds
- Delivery/Examination Beds
- Infant/Pediatric
- Bed Side Lockers
- IV Stands
- Trolley / Carts
- Stretchers / Instrument Cupboards
- Hospital Linen
- Medical Curtains / PVC Floor
- Accessories



# HOSPITAL BEDS

Functional, comfortable & long lasting

## Epoxy coated semi-fowler bed B-32



- Epoxy coated bed frame, with detachable epoxy coated headboards,
- One function, which can be operated by cranks, the details are as follows: (1) back rest: 0°-70°±2°
- Freight saving knock-down construction

## Epoxy coated semi-fowler bed B-32-1



- Epoxy coated bed frame, with detachable stainless steel headboards.
- One function, which can be operated by crank, the details are as follows: back rest: 0-70±2°
- With anti-static casters
- Freight saving knock-down construction.

size: 2030mm(L)\*900mm(W)\*530mm(H)  
Packing size: 2070\*940\*305mm

## Epoxy coated semi-fowler bed B-31-1



- Epoxy coated bed frame, with detachable stainless steel headboards & aluminum alloy collapsible side rails.
- One function, which can be operated by crank, the details are as follows: back rest: 0-70±2°
- Anti-noise rubber at the foot base
- Freight saving knock-down construction.

Size: 2030mm(L)\*900mm(W)\*530mm(H)  
Packing size: 2070\*940\*305mm

## Semi-fowler Manual Bed B-21-1



- Functions:**
- Back section up&down
  - Knee section up&down
- Standard Configurations:**
- One pair of headboard/footboard
  - One pair of collapsible aluminum alloy side rails
  - Manual crank systems(1)
  - I.V. Pole holes (4)
  - Drainage hooks (2)
  - Individual locking castors (4)

Size : L 2140 x W 940 x H 500mm

## Movable full-fowler bed with ABS head/foot board B-11-1



- Epoxy coated bed frame, with Collapsible stainlesssteel side rails, and detachable ABS engineering plastic headboards
- Two function , which can be operated by crank, the details are as follows: Backrest: 0°-70°±2° Knee Rest: 0°-35°±2°
- Protection strip in bed lateral side & Anti-bumper in four corners, with I.V. rod locations
- Four dia-125mm castors, which are with individual brakes
- Freight saving knock-down construction.

Size: 2140mm(L)\*940mm(W)\*500mm(H)

## Three function manual bed with ABS headboards A-5



- Epoxy coated bed frame, with Collapsible stainless steel side rails, and detachable ABS engineering plastic headboards,
- 3 function , which can be operated by crank, the details are as follows: Back Rest: 0°-70°±2° Knee Rest: 0°-35°±2° High-low: 530mm-720mm
- Protection strip in bed lateral side & Anti-bumper in four corners, location for IV rod in each corner
- Four dia-125mm castors with individual brakes

Size: 2140mm(L)\*940mm(W)\*530mm-720mm(H)  
Packing size: 2070mm\*970mm\*405mm

## Semi-fowler bed with ABS headboards DA-3-3



- Bed frame welded by profile steel are stable and reliable.
- The bed platform is treated with advanced electrostatic plastic-spray which is anti-aging and anti-rust.
- Aluminum alloy collapsible side rails with unique pinch resistant design are made of aluminum and carbon steel, light and reliable.
- Motors of safe voltage.
- High quality ABS engineering plastic head/foot boards are beautiful and generous, which is easily detachable and stable.
- Three functions, which can be operated by 3 pcs electric motors , the details are as follow: back Rest: 0-70±2° Knee Rest: 0-35±2° High-low: 500~750mm

Size: L2140\*W940\*H500-750mm  
Packing Size: 2090\*990\*450mm (wooden case)

## Five-Function manual Medical bed with ABS head/foot board bed

### S-2



- One pair of H/F boards (B)
- Tuck-away ABS engineering plastic side rails (4)
- ABS Tuck-away crank handles (3)
- Function separation converter
- Molded bed board with ventilation holes
- I.V Pole holes (4)
- Drainage Hooks (2)
- Dia.125mm central locking castors (4)

Function separation converter

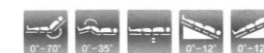

SIZE: L2150 x W940 x H510-780mm

# HOSPITAL BEDS

Functional, comfortable & long lasting

## Full-fowler orthopedics bed C-5-1



- Epoxy coated bed frame, with detachable lat tube headboards
- 2 function, which can be operated by crank, the details are as follows:
- back rest: 0°-70°±2° : knee rest: 0°-35°±2°
- with stainless steel traction frame at the foot/head end.
- Anti-bumper in four corners, with I.V. rod locations
- Anti-noise rubber at the foot base
- Freight saving knock-down construction.

Size: 2170mm(L)\*940mm(W)\*500mm(H)

## F-44 Foldable accompany chair



Size: L1960\*W720\*H400mm  
Packing size:820\*740\*600 mm

### main feature:

1. epoxy coated steel frame, high quality sponge top with artificial leather cover
2. base with castors
3. this product can be used as both a chair and a bed

# HOME CARE BEDS

Family deserves the best

## Two function electric bed for family DB-2



- Epoxy coated bed frame, with Collapsible aluminum alloy side rails, and detachable wooden headboards;
- Two function , which can be operated by electric motor, the details are as follows: Back Rest: 0°-70°±2° Knee Rest: 0°-35°±2°
- Detachable wooden board in bed lateral side, corner with IV rod locations
- Four dia-125mm castors, which are with brakes
- High quality T-motion motor

Size: 2070mm(L)\*1080mm(W)\*500mm(H)

## MATTRESS

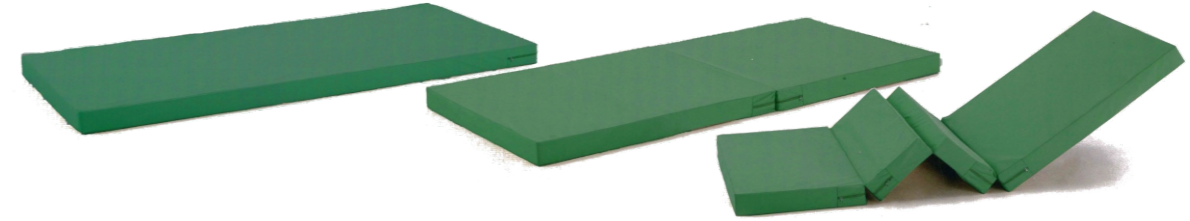

### Standard Flat Mattress

Mattress for flat & electric bed

### Two Part Mattress

Mattress for Semi-Fowler bed

### Four Part Mattress

Mattress for Fully-Fowler bed

# EXAMINATION BEDS & DELIVERY BEDS

## Examination Tables HF-ET150

Stainless Steel



- Strong structure in stainless steel /resin coated rectangular tube.
- Adjustable head sections.
- Artificial Leather Padding

Dimensions: 1860mmX600X700mm

Backrest: 0 -75

Loading Capacity: 200kg

## Manual Delivery / Examination HF-DB 100



- Strong structure in stainless steel/resin coated rectangular tubes.
- Adjustable head and leg sections.
- Artificial Leather Padding
- Complete with stainless steel bowl Ø30cm & leg holders.
- Guard rails

dimensions: 1860X600X700mm

Backrest: 0 -75

Loading Capacity: 200kg

## Obstetrics Manual Delivery Bed HF-DB 150



Heavy duty metal frame, electro-statically painted with epoxy powder.

- Fully adjustable legs support
- 3 single drives + 1 control unit + 1 patient handset
- Mattress with removable cover
- Labor hand grips
- Fluid basin
- Build in leg section which is easily placed under the bed's surface

### movements:

Trendelenburg 12°

Range 380 mm

Back section 70°

Lowest height 520-540 mm

# EXAMINATION BEDS & DELIVERY BEDS

## Obstetric Electric Bed B-48



- Bed frame welded by profile steel
- Telescopic working table , to be controlled by linear bearing,
- Telescopic length : 550mm;
- High quality ABS engineering plastic detachable head/foot boards and tuck-away side rails.
- Three function , which are operated by electric motor :
- Back rest: 0-70±5°
- High-low: 300±30mm
- Trendelenburg & Reverse Trendelenburg 12±2°
- Equipped with 8cm thickness high density sponge mattress covered with artificial leather.
- Adjustable leg support and sliding grip holder.
- Four dia-125mm casters, which are with central brakes

size: 2000/1450mm(L)\*900/660mm(W)\*620/920mm(H)

# BEDSIDE LOCKERS & TROLLEYS



Size:920\*550\*865mm

- This products is with innovative design, reliable structure and harmonious color matching.
- Top cover is made of high quality engineering plastic, and installed with a buffer device, which make open and close muted.
- The disposable plastic bags can be put inside the dirt bags, convenient and sanitary.

Size: 920\*550\*865mm



## trolley for treatment F-16

- Stainless steel frame, three shelves, base with swivel castors (two of them with brakes)
- Oxford cloth bag for waste

Size: L950\*W500\*H900mm  
Packing size: 990\*770\*560mm



## ABS trolley for appliance F-47

- Stainless steel frame with abs engineering plastic shelves boards
- Stainless side rails, four castors, two of them with brakes

Size: L720\*W460\*H970mm



## Bedside Cabinet D-1/D-2

- ABS engineering plastic material
- With one food board, one drawer,one small door (inner with one shelf board)
- Tower shelf in lateral side

Size: 475\*475\*750mm



## Instrument Trolley- Stainless Steel [G4]

Dimensions: 600x450x900mm

## Bowl Stand



### Bowl Stand (Double) Stainless Steel base



### Bowl Stand (Single) Stainless Steel base

## Emergency / Anaesthesia Trolley F-45-2

- Specially designed for nurse medicines to patient.
- Two sides unit cassette for medicine and one side plate cassette for medicine
- Easy to removed.
- Installed multi-bin container at the bottom; convenient for storing medical consumables
- Multi structure enables different combination upon requirement.
- Humanization designed push, handle and efficient structure.
- Central locking system
- Medicine cassette unit can be customized with exchanging with drawers

size: 475\*475\*750mm



## Ward Trolley F1

- Epoxy coated steel construction, mainly consists of groups of drawers for storing different kinds of goods.
- base with dia-125mm castors, two of which are with brakes.
- Four corners of the base are equipped with bumpers
- With related accessories for anesthesia as bellow:
- IV pole
- Waste bin
- Stainless steel cup
- Oxygen tank holder
- Pushing handle

Size: L650\*W420\*H1020mm



### Anaesthesia & Medicine Trolley F-50

- Specially designed for nurses to administer medicines to patient.
- Two sides unit cassette for medicine and one side plate cassette for medicine
- Installed multi-bin container at the bottom
- Multi structure enables different combination upon requirement.
- Humanization designed push.
- Central locking system
- Medicine cassette unit can be customized exchanging with drawers.

Size: L850\*W515\*H985mm



### Emergency Trolley F-46

- Aluminum alloy column with ABS engineering plastic construction Base With Dia -125mm castors two of which with brakes.
- Drawers, medicine cassettes inside the adjustable drawers can be organized easily and freely with related accessories for emergency: IV pole, Waste bin, File cassette, Needle disposal container, Defibrillator shelf
- Lateral side with sliding working shelf
- Back with ABS plastic cardiac boards
- Oxygen tank holder
- Central locking system

Size: L850\*W520\*H1045mm



### Medication Trolley F-45

- High quality alloy column ABS materials, with lateral working board, base with four dia--125mm castors, two of them with brakes; 5 drawers, adjustable medicine cassettes and waste bin.

#### Related accessories :

- IV rod
- Two waste tubs
- File cassette
- Defibrillator Shelf
- Sliding side shelf & Central locking system

Size: L720\*W460\*H970mm

## INFANT/PEDIATRIC BEDS

Designed for safety & comfort

### Luxurious Infant Bed B-46



- Clear plastic bassinet to secure clear visibility for observer.
- Inclination angle adjustable by gas spring, 0-12°. Height adjustable by gas spring, 920-1070mm.
- 100mm dia. Polyurethane single-wheel casters with brakes on opposite corner, The smooth rotating caster will provide silent transportation.
- Pink color and Blue color for options.

Size: 870\*530\*920~1070mm

### Movable Hydraulic Over Bed Table F-32 [MF-652]



- Epoxy coated steel frame with top wooden board, base with swivel castors
- Height can be adjusted by gas-spring from 700 to 960mm
- Wheels with brake
- Blue part is ABS engineering plastic

size: L795\*W400\*H700--960mm

## STRETCHERS & INSTRUMENT CUPBOARDS

Designed for safety & comfort

### Stainless steel infant bed B-39



- Stainless steel frame
- Base with castors

size: 810mm(L)\*460mm(W)\*960mm(H)

### Luxurious Hydraulic Stretcher



- Epoxy coated bed frame, collapsible aluminum alloy side rails and pushing handle
- Bed platform can be X-ray transparent, with sliding X-ray cassette holder for the whole body from head to toe;
- Five functions:
  - (1) Back rest (operated by gas spring)
  - (2) Knee rest (operated by crank)
  - (3) Up-down function (operated by hydraulic pedal)
  - (4) Trendelenburg (operated by hydraulic pedal)
  - (5) Reserve-trendelenburg (operated by hydraulic pedal)
- Four dia-150mm castors, with central brake system, with fifth wheel for revolving around;
- Four corners with anti-bumpers for protecting and hole for I. V pole;
- 1. IV rod 2. Mattress thickness: 8cm;
- The stretcher is equipped with infusion poles, drainage hooks and collapsible aluminum alloy side rails;
- It is the best choice for emergency room and ICU ward for transferring patient.

# STRETCHERS & INSTRUMENT CUPBOARDS

## Patient Stretcher Trolley - E6



### Stainless steel stretcher

- Sealed stainless steel, the top part can be taken part from the main frame and can be used separately as a stretcher.
- Bed frames are made of high quality stainless steel
- Extra accessories:
  1. I. V. Rod
  2. Storage basket
- Freight saving knock-down construction.
- Bed plate surface is using PVC, sponge of high quality and laminated panel of high density, beautiful and comfortable

## Luxurious hydraulic stretcher - E - 8

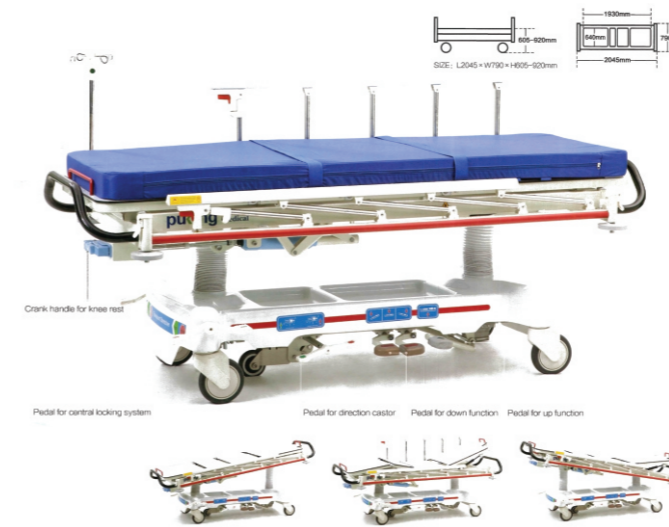

SIZE: L2045 x W790 x H605 -920

- Epoxy coated bed frame, collapsible aluminum alloy side rails and pushing handle, with ABS plastic base;
- Bed platform can be X-ray transparent, with sliding X-ray cassette holder for the whole body from head to toe;
- Five functions :
  - (1) back rest (operated by gas spring)
  - (2) knee rest (operated by crank)
  - (3) up-down function (operated by hydraulic pedal)
  - (4) trendelenburg (operated by hydraulic pedal)
  - (5) reserve-trendelenburg (operated by hydraulic pedal)
- With four dia-150mm castors, with central brake system, with fifth wheel for revolving around;
- Four corners with anti-bumpers for protecting and hole for I.V pole
- Extra accessories:
  1. IV rod
  2. mattress thickness: 8cm

## Stainless steel stretcher for emergency treatment with adjustable height E-5



- The main material of this stretcher is stainless steel
- Two functions: Back rest: 0-10±2° (controlled by gear mechanic system) Height Adjustment: 680-900mm (controlled by manual crank)
- Four pcs 125mm diameter castors with brake

Size: L1950\*W650\*H680/900Mm

## Ambulance Car Trolley HF-HS200



- Hand Rocking with IV Pole
- Adjustable Guard rails & Castors

Dimensions:1950mmx560mmx850mm  
 Size of the castors: Ø160mm  
 Load bearing: <120 kgs  
 Weight: 32 kilograms; positive negative 2

## Luxurious Stretcher E-3



- The main frame is automatically pressed and casted by the best alloy aluminum. Nice and strong in appearance.
- The surface and side rails are plastic sprayed by imported ABS materials, strong and beautiful.
- Single operation design for bed surface, the upper part is used hydraulic as the holding energy source, easy to operate.
- Hydraulic transmission to choose a function of half lie situation. Adjusting height between 530 and 820mm.
- International central control braking system, to increase the steady. Direction leading wheels easily come to an ideal situation by only one person.
- Retractable 5th wheel steering system

size: 1930x595x530/820mm

## Ambulance Car Trolley HF-HS300



- Made of aluminum alloy
- It is the medical necessities for all arms, hospitals and first-aid centers.
- This new-type product is a kind of stretcher suitable for the skyscraper and give first aid, shift the sick and wounded.
- This stretcher can shift the critical patient in the lift and narrow corridor.

Dimensions:1920mmx560mmx900mm  
 Load bearing: less than 120 kilograms  
 Size of the Castors: Ø125 mm

# HOSPITAL LINENS

## COMFORT that comes in all sizes



### Tunic & Trouser

- Set-in sleeves
- Four pockets with pencil /instrument divisions
- 4" side vents
- Regular Sizes are 27.25" at Medium
- 65% Polyester / 35% Combed Cotton W/ Soil Release Finish



### Doctor's / Lab Coat

- Five-button front closure
- One-piece straight back
- Side hand access
- Three front pockets
- Regular 42" length & 44" Tall Length
- 65/35 Poly/Cotton

Size	XS	S	M	L	XL	2XL	3XL	4XL	5XL
Bust	30-32	34-36	38-40	42-44	46-48	50-52	54-56	58-60	62-64
Waist	26-28	29-31	32-34	35-38	39-42	43-46	54-56	58-60	62-64
Hip	34-35	36-38	39-41	42-45	46-49	50-53	54-56	58-60	62-64



### PVC Apron

- Green PVC / Nylon Apron complete with ties (107cm x 76cm)
- Water Proof
- Standard Hospital Size



### Surgical Drapes

- 100% Cotton
- One square meter with "O" hole and plain



- 100% Cotton



### Child's Gown

- Green PVC / Nylon
- Apron complete with ties (107cm x 76cm)
- Water Proof
- Standard Hospital Size



### Theater Clogs

- Steam Autoclavable at 134°C / 274°F
- Machine washable at 90°C/ 140°F
- Complying with 6 ISO & EC standards for professional footwear EN347-1
- Antistatic guaranteed, slip resistant, shock absorbing
- Closed upper for max protection
- Lateral ventilation to keep feet fresh



### Doctor/Nurse Cap

- 100% Cotton
- One square meter with "O" hole and plain



### green Gown

- 100% Cotton
- One-piece straight back
- Side hand access
- Regular 42" length & 44" Tall Length



Candle wick Bed Cover



Bed Sheet (Pair)



Pillow & Case



Pillow & Mackintosh



Cellular Blankets

These are plain fabric bedspreads, good appearance, only suitable for summer, blanket is needed, easy to wash and iron, easy to dress on the bed, easy to fold and pack the finishing binding is thin it eliminates bacteria and the colours are soft.

Fabric: 100% Cotton | Size: 200cm X 200cm

Cellular Blankets: Colours available: White, other colours available on order. Life span: 1 - 2 years on regular wash. Monogramming can be done on request at an extra cost.

### 4 Fold Ward Screen WS200



- Tubular steel framework - 7 legged
- Resin coated/stainless steel
- Ø50mm swiveling type castors

dimensions for each panel /Fold: (560x1850)mm

# ACCESSORIES

FOR every hospital, clinic and practice



### Stainless steel stool F-36

- Stainless steel seat and supporting pole.
- Seat diameter is 29cm, the height can be adjust by gas spring.

size: 380\*380\*520mm



### Nurse Stool F-36-1

- Variable height by gas spring;
- Aluminum base, 5 branches with casters;
- High quantity cushion top and durable back ;
- Knock down construction

# ACCESSORIES

FOR every hospital, clinic and practice



**Quick Bucket**

- Stainless Steel



**Stainless Steel BucketBin F-30-1**

- Stainless Steel
- Inner Plastic basket
- Foot pedal to open



**2-Step Footstool F-36-1**

- Stainless steel frame, cover with ABS rubber
- Foot with anti-noise rubber sheath

**IV Poles  
Stainless Steel**



- Stainless Steel
  - Durable
  - Castors for easy movement
  - Base designs to allow units to be pushed close to beds
- Size: 870×530×920~1070mm



Durable IV Poles from CROWN HEALTHCARE



THEATRE SOLUTIONS



## THEATRESOLUTIONS

- Operating Tables
- Operating Lights
- Examination Lights
- Suction Machine
- Anaesthesia
- Endoscope
- Diathermy Machines
- Surgical Instruments
- Orthopedic
- Holloware
- Incubators
- Infant Warmers

# OPERATING TABLES

## Functional & Ergonomic



**OT200 Operation Table**  
manual With Accessories

- Widely used in Chest, Abdominal, ENT, GYN/OBS, Urology & Orthopaedic Surgeries.
- Hydraulic lift by foot pedal, head operated movements.
- The base and column cover sections are all made of premium 304 stainless steel.

**Main Function:**

- Table Top - 2000mmx 500mm
- Height Without Pad - 780mm x 100mm
- Trendelenburg / Left Trendelenburg +220/-220
- Lateral Tilt [Left/Right] +180/-180
- Back Plate [Up/Down +750/-150
- Leg Plate [Horizontal Opening +900
- Flex +2250

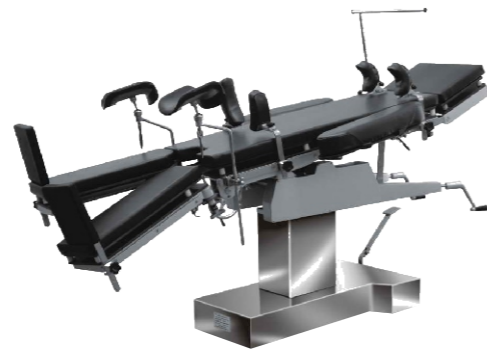

**OT300 Operation Table Superior**  
Manual With Accessories

- Widely used in Chest, Abdominal, ENT, GYN/OBS, Urology & Orthopaedic Surgeries.
- Hydraulic lift by foot pedal, head operated movements.
- The base and column cover sections are all made of premium 304 stainless steel.
- The tabletop is made of composite laminate for X-ray procedures enhancing image quality.

**Main Function:**

- Length/width: 2000mm/500mm
- Elevation (up/down): 780mm/1020mm
- Trendelenburg: 22°
- Reverse Trendelenburg: 22°
- Lateral Tilt: 18/° 18°
- Head rest(up/down): 45° /70°
- Leg Plate(up/down): 15° / 90°
- Back Plate(up/down): 75° /15

**OT400 Electric Operating Table With Accessories**  
MOT-049



- Widely used in Chest, Abdominal, ENT, GYN/OBS, Urology & Orthopaedic Surgeries.
- Electronic operated movements.
- The base and column cover sections are all made of premium 304 stainless steel.

**Main Function:**

- Length/width: 2070mm/500mm
- Elevation (up/down): 780mm/1020mm
- Trendelenburg: 25°
- Reverse Trendelenburg: 25°
- Lateral Tilt: 15/° 15°
- Head rest(up/down): 45° /90°
- Leg Plate(up/down): 15° / 90°
- Back Plate(up/down): 75° /20°
- Frequency: 50Hz/60Hz
- Voltage: 220v/110v
- Power Capacity: 1.0Kw

**UniBase 30**  
Electro-Hydraulic  
Operating Table MOT-042



Unibase 30, simple good operating table:

- Weight capacity of 185 Kg in normal position
- Longitudinal shift (optional) with 300mm
- Adjustment body elevator (optional) with 120mm
- Battery power for about one week time
- Mechanical brake system for optimum stability
- Detachable & split leg plate for lithotomy position

**MT 400 Obstetric Table Superior**  
Manual With Accessories



Mt400 delivery table is used in all kinds of surgical operations, especially for gynaecology exam. manual system obstetric delivery table with CE certificate. Endearing appearance, various colors of mattress available, optional infant trolley. The base and column cover all made by premium 304 stainless steel. Good performance on anti-rust and easy to clean.

- various mattress colors for your option
- table base and column adopt premium S/S
- great performance and flexibility
- user- friendly during surgery process
- ergonomic working conditions for doctors

**Electro- Hydraulic Operating Table**  
Hybase 300 MOT-030



- Better mattress for comfort of patients
- Safe and efficient patient positioning
- Know-how for maximizing the versatility
- Decompression mattress with anti-static, waterproof and seamless design
- Electric longitudinal shift towards head side with 200 mm
- Electric longitudinal shift towards foot side with 100 mm providing more space for gynaecology and urology
- Weight capacity of 185 Kg in normal position
- Battery operations for 50-80 operations
- Mechanical brake system for optimum stability
- Return to original position with one button
- Radiolucent table plate for free C-arm access
- Three control panels including remote panel, backup control & foot switch



# OPERATING TABLES

## Functional & Ergonomic

### HyBase™ 6100 Operating Table MOT-040



Engineered for increasingly complex surgical cases, HyBase 6100 requires minimal effort and Time to position a patient in a safe, comfortable and efficient way. Mindray has answered demands for a complete operating table solution.

- Decompression mattress for the comfort of patients to remove the incidence of decubitus ulcer, with an antistatic, waterproof and seamless design
- High level weight capacity in normal and reverse positions
- Internal battery maintaining power supply for 50- 80 operations 600 mm lowest table position after adjusting the patient position, making it suitable for neurosurgery and minimally invasive surgery
- Electric brake system for optimum stability
- Return to original position with one button
- Option with Carbon fiber table top
- Electric longitudinal shift function with 320mm combined with radiolucent table plate gives free C-arm access for the whole body
- Three control panels including remote panel, columnpanel & foot switch

### TS-OL040 MOT-070

- 4 Reflector Operation
- Light on Castors

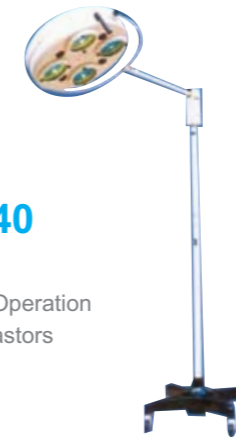

### TS-OL040 MOT-080

- Operation Light
- 4 Reflectors on Castors with backup



### HyLED 7 Series LED Surgical Lights



- 330° rotatable integrated HD & SD camera
- Perfectly integrated into Laminar Flow

# THEATRE LIGHTS

## Operation Lights



### TS-OL060 5-Reflector Ceiling Mounted MOT-090

- Illuminance:  $\geq 50,000\text{Lux}$
- Colour temperature:  $4000\pm 500\text{K}$
- Power supply voltage: AC 220V/ 50-60 Hz
- Rated voltage of bulb: 24V
- Rated power of bulb: 25W
- Input power: 120VA
- Lowest height of installation: 2900mm
- Bulb: Cold light source



### TS-OL080 9-Reflector Ceiling Mounted

- Light intensity  $\geq 100000\text{Lx}$  at 1m distance
- Color Temperature :  $4000+ 500\text{K}$
- Color rendering index :  $Ra \geq 90$
- Main Voltage : AC110V/220V + 22V, 50/60Hz
- Rated Voltage of Bulb : 24V
- Rated Power of Bulb : 25W



### TS-OL060 12-Reflector Ceiling Mounted MOT-110

- Glass Reflectors
- Illuminance:  $80000\sim 120000\text{Lx}$
- Color Temperature:  $4300\pm 200\text{K}$
- Color rendering index:  $Ra \geq 90$
- Dia of light spot: 100-300mm
- Mains Voltage:  $\sim 230\text{V}60\text{Hz}$ ;  $\sim 110\text{V}60\text{Hz}$
- Rated Voltage: 24V
- Rated Power Of Bulb: 25W

40,000 hours of operation

### HyLED 8600 LED Surgical Lights



- Long-lasting LED technology for more than 40,000 hours of continuous operation.
- Trigon-shaped design for excellent laminar low compatibility.
- 2 mega-pixel HD camera for high-performance video system.

### HyLED 9 Series LED Surgical Lights AICS (Automatic Illumination Control System)



- HyLED has four sensors that are able to detect if the head of the clinician obscures any area of the light-head and automatically adjust the light intensity in the remaining areas.
- The result is a consistent level of illumination that requires no manual adjustment of the light intensity.
- HyLED 9 Series is a high-end surgical light that features the innovative AICS function and a laminar airflow compatible design. Its adjustable light diameter as well as variable levels of light intensity and color temperature make it the optimal lighting solution for all surgical disciplines.

# SURGICAL PENDANTS

## Medical Supply Pendants



**HyPort B30**  
Medical Supply Unit

With the higher requirement of the healthcare and continuing focus on the efficient clinical workflow, the advanced medical technology is always demanded from the patients and hospital. While some hospitals have limited space and budget, they search for a simple pendant solution to enhance the work efficiency and better care for the patient. Mindray HyPort B30 provides a simple, compact and cost-effective design for Anesthesia Pendant and Surgical Pendant in OR and ICU Pendant to meet this requirement.

- Less space needed with slimmer column design
- Easy to handle for nurse after reducing pendant weight
- Hygienic surface with an-bacteria coating
- Built-in rails for accessories and no exposed screws



**Hyport 3000**  
Mechanical Pendant

Hyport 3000 is a mechanical pendant that is configured with mechanical arms.

The mechanical arm can allow for horizontal rotation by manual 0 with 340 .The loading weight capacity varies according to different length and loading version of arms, light, medium and heavy loading arm.

- Less space needed with slimmer column design
- Easy to handle for nurse after reducing pendant weight
- Hygienic surface with an-bacteria coating
- Built-in rails for accessories and no exposed screws



Find out about our after sales service solutions

# ANAESTHESIA

## Anaesthesia Machines - MINDRAY

**WATO™ EX-20**  
Anesthesia Machines



- The main unit includes a Ventilator, mechanical low meters, breathing circuit with 1 CO2 absorber, 1 drawer, 1 lithium battery (90 min) and pipeline pressure gauges.
- Has a colour LCD screen size of 7 inch
- Volume controlled ventilation with a tidal volume of 40 - 1500 ml
- Classical low meters for O2, N2 and Air
- Support up to 2 vaporizer positions (ACGO) that allow you to use 3rd party semi-open circuits
- Backup batteries support up to 150 min continuous work
- Intelligent alarm management, e.g. permanent, silent volume/apnea
- Besides Volume, there is VCV, which can be assisted in-patient once the operation has ended.
- Has an electronically controlled, pneumatically driven ventilator.
- Breathing circuit fully autoclavable at 134 c and nature latex free
- Easy to disassemble and assemble the components of the breathing circuit hence making it convenient for cleaning and maintenance purposes

**new WATO™ EX-35**  
Anesthesia Machines  
better performance than performance



- The main unit includes Ventilator, ACGO, breathing circuit, one Co2 canister, one drawer and one lithium battery.
- Color LCD screen of 8.4 inch
- Volume controlled ventilation with a tidal volume of 20 - 1500 ml hence making it suitable for patients of any age, from infant to adult.
- Classical low meters for O2 , N2 and air
- Support up to 2 vaporizer positions (ACGO) that allows you to use 3rd party semi-open circuits
- Backup batteries support up to 150 min continuous work
- Alarm; low airway pressure, high airway pressure, oxygen failure alarm, apnea alarm, breathing rate alarm, O concentration 2
- Has a compact breathing circuit with 2.6l circuit volume, especially for low low anaesthesia.
- Has latex free PSU material, autoclavable at 134C.

# ANAESTHESIA

## Anaesthesia Machines - MINDRAY

### WATO™ EX-65/55

Anaesthesia Machines



- The main unit includes Ventilator, ACGO, electronic low meters and 1 backup low meter, breathing circuit with 1 Co2 absorber, 2 drawers, LED light, alarm light, 1 lithium battery (60 min).
- Wato 55 had a Color LCD screen of 8.4 inches
- Wato 65 has a similar screen size of 10.4 inches.
- Volume controlled ventilation with a tidal volume range of 20 - 1500 ml making it suitable for patients of any age from infant to adult.
- Electronic low meters for O2, N2O and Air with a back tube for the emergency.
- Supports up to 2 vaporizer positions
- An electronically controlled, pneumatically driven ventilator
- Modular design monitoring for anaesthetic agents, paramagnetic oxygen, Etco2 and BIS measurement
- Intelligent alarm management permanent silent volume/apnea alarm.
- Breathing circuit fully autoclavable at 134 degrees C and nature latex free
- Breathing circuit is easy to disassemble and assemble all the components and hence convenient for cleaning and maintenance

### WATO™ A7

Anaesthesia Machines



- A7 anaesthesia workstation
- Electronic gas low with customizable settings
- Quick keys for changing O<sub>2</sub>
- Agent usage calculation, case by case
- 15" colour LCD touchscreen with control pad
- HL7 connectivity for AIMS and EMR data export
- Automatic system compliance and fresh gas compression
- Advanced ventilation modes, including SIMV-VC, SIMV-PC, and PS, come standard
- Ergonomically designed for comfort and workflow efficiency
- Large stainless steel work surface
- Superb adjustable lighting
- Additional pullout worktable
- Three large lockable drawers

# PATIENT MONITORS

## Monitor Machines

### uMEC



- Integrates seamlessly with Mindray's Hypervisor VI Central Monitoring System.
- Up to 8 hours battery runtime
- Quick BP measurement technique reduces cuff discomfort
- Anti-interference SPO2 algorithm provides accurate measurements
- HR/BP Analysis
- Robust and lightweight construction, certified 0.75m drop test and IPX1 compliant
- Low power consumption with fanless design reduces risk of cross-contamination

### IMEC 12



- It's portable structure
- Quick and easy monitoring
- A touch screen with an intuitive user interface,
- Flexible networking capabilities and accurate monitoring functions make iMEC the optimal choice for sub-acute care
- It reduces your hospital's ecological footprint and contributes to a sustainable environment
- Optional IBP & ET CO<sub>2</sub>

### IMEC 8



Mindray's iMEC has been designed based on a solid foundation of experience and knowledge in patient monitoring. It integrates Mindray's proven technology, rich know-how in ergonomic design and the latest ASIC technology, thereby delivering impressive reliability and performance.

### IMEC 10



Its portable structure, a touch screen with intuitive user interface, flexible networking capabilities and accurate monitoring functions make iMEC the optimal choice for sub-acute care. At the same time, iMEC is also a patient monitor series with "green" credentials. It reduces your hospital's ecological footprint and contributes to a sustainable environment.

# DEFIBRILLATOR

## Easy to use with large display



### BeneHeart D3

- 1-2-3 steps to deibrillation, color-coded buttons and highly visible patient data simply manual deibrillation
- Large, highly visible alarm lights advises caregivers a change in the patient's condition.
- Buttons for energy selection, charging and shock delivery improve ease of use clinicians.
- Functions are accessed simply and quickly using the rotary control and quick action keys.
- Load selection button gives quick access to the optimum ECG waveform
- Multiple power supply options enable the BeneHeart D3 to be used in a variety of locations.



**mindray**  
healthcare within reach

### BeneHeart D6

- 4-in-1 design including: monitoring, Manual Deib, AED, and Pacer
- All necessary optional Vital Sign monitoring functions integrated, making it convenient for emergency use without the additional need for a separate patient monitor
- Large and vivid display with 4 waveforms to ensure easy viewing of ECG and vital signs
- Compact design: easy to carry and easy to operate
- Deibrillation, synchronized cardioversion and AED with Biphasic technology
- Up to 360J escalating dose energy to maximize deibrillation success
- Powerful power capacity with batteries to support continuous long time monitoring and shocks during transport without external power supply.
- Powerful data storage; no worries about losing information.



### LIFEPAK 15 Monitor/Defibrillator

The LIFEPAK® 15 monitor/defibrillator is the standard in emergency care for ALS teams who want the most clinically innovative, operationally effective, and LIFEPAK TOUGH™ device available today



### LIFEPAK 1000 Defibrillator

The rugged LIFEPAK® 1000 defibrillator is an easy-to-use automated external defibrillator (AED) designed for professional responders. A large, intuitive screen displays graphics and ECG readings that are clear and easy to read. The 1000 also features cprMAX™ Technology which minimizes CPR interruptions by allowing compressions to continue during AED charging.



**PHYSIO CONTROL**

### LIFEPAK CR® Plus AED

The LIFEPAK CR® Plus AED was created for lay users in commercial and public settings. For use by the first person at the scene of a cardiac arrest, they are designed for minimally-trained rescuers. The AEDs tell the rescuer exactly what to do, one step at a time, in a simple, clear voice. It is easy to understand and use in a cardiac emergency, when every second counts.

# DIATHERMY UNITS

## Surton LED



### SURTRON 160

SURTRON 160 is a radio surgical unit, which is suitable for light and medium surgery.

Allows a highly professional surgery thanks to the ergonomic and safety solutions normally utilized.

- Plate/patient circuit watching
- Delivery me watching
- Output power watching
- Self-analysis

Features: monopolar cutting, monopolar coagulation, bipolar coagulation  
Type: High frequency  
Cutting power: 150 W  
Coagulating power: 100 W, 80 W, 60 W



### SURTRON 200

Supplies RF operative powers either for programmable me as short as hundreds of a second.

SURTRON FLASH can supply RF operative powers either for programmable me as short as hundreds of a second.

- Patient/Plate circuit monitoring
- Output power monitoring
- Self-check control

Features: Monopolar cutting, monopolar coagulation, bipolar coagulation  
Type: radio frequency  
Cutting power: 200 W  
Coagulating power: 150 W, 90 W, 80 W

### SURTRON 300 HP



Supplies RF operative powers either for programmable me as short as hundreds of a second.

SURTRON FLASH can supply RF operative powers either for programmable me as short as hundreds of a second.

- Patient/Plate circuit monitoring
- Output power monitoring
- Self-check control
- H.F. Leakage currents control
- Compensation of mains luctuation

Features: Bipolar cutting, monopolar cutting, monopolar coagulation, bipolar coagulation  
Type: high-frequency  
Cutting power: 300 W  
Coagulating power: 100 W

Safe and Ergonomic

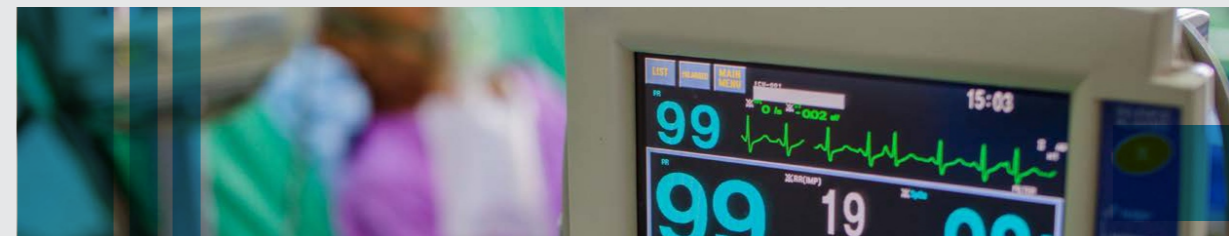

# DIATHERMY UNITS

## Surtron Led

### SURTRON 400 HP



Features: bipolar cutting, monopolar cutting, monopolar coagulation, bipolar coagulation  
 Type: high-frequency  
 Cutting power: 300 W  
 Coagulating power: 100 W

Can be used to execute monopolar and bipolar surgery in the many fields of application where it is requested high precision and reliability

SURTRON® HP can be used to execute monopolar and bipolar surgery in the many fields of application where it is requested high precision and reliability

- Patient/Plate circuit monitoring
- Output power monitoring
- Self-check control
- H.F. Leakage currents control
- Compensation of mains fluctuation

# SUCTION MACHINES

## Powerful Aspiration

### ASKIR C30



ASKIR C30 is a portable suction unit on castors for the aspiration of body liquids, oral, nasal and tracheal aspiration in adults or children. For professional use and with a powerful aspiration of max 40 l/min, ASKIR C30 comes with double collection jars and on a stand with five castors for easy transport. Main unit equipped with vacuum-meter (bar & kPa) and vacuum regulator.

- Liquid Collection Jars with overflow valve system (different options, see below)
- 8x14 Silicone Tubes (autoclavable) + Conical Connector ø 10-11-12mm
- An bacterial & Hydrophobic Filter (single-patient)  
 Power Cord with Schuko plug Footswitch (may be ordered at a later time)

# SUCTION MACHINE

## Powerful Aspiration

### New HOSPIVAC 400



NEW HOSPIVAC 400 has been designed for professional aspiration of bodily fluids, gases, tissues or bones of the patient during or after surgery. The state-of-the-art oilless pump guarantees high performances with excellent suction capacity and max vacuum reachable within a few seconds, with no need for maintenance. A clear dashboard along with a full range of accessories makes it the ideal device for surgical suction and liposuction.

- Overall Dimensions: 460mm(L) x 850mm(H) x 420mm(W)
- Capacity: 90l per minute
- Functioning: Continuous
- Unit Weight: 20kg
- Voltage: 230V / 50Hz
- Absorbed Power: 300VA
- Fuse: 1 x 4A 250V
- Maximum Vacuum: -0.90 BAR
- Noise Level: 46,4 dB

### Suction Machine SM200D



Oil Free Lubrication Pump  
 High vacuum, high low

- Power Supply: AC220V±10% 50Hz±2%
- Input Power: 120VA
- Max Vacuum: >90 kPa
- Adjustable Vacuum Range: 20 kPa~Max vacuum
- Max Airflow: ~20L/min
- Suction Bottle (glass): 2500ml/bottle, 2 bottles in a group
- Sound Level: 60dB(A)
- Dimension: 360 X 320 X 480 (mm)
- Weight: 15.5 kg

### New HOSPIVAC 350

With autoclavable collection vessel and system overflow valve, antibacterial and hydrophobic filter, complete set of tube 8 x14mm, Conical probe Contact

- Power supply: 230V - 50Hz
- Maximum aspiration - controllable: -0.90 Bar / -90kPa / -675 mmHg
- Flow maximum aspiration 60liters / min
- Power consumption: 230 VA
- Hedging 1 x 4 A 250V
- Intermittent operation: Continuous

### Oil Free Lubrication Pump



- Power Supply: AC220V±10% 50Hz±2%
- Input Power: 90VA
- Limit Negative Pressure: > 0.075Mpa (760mmHg)
- Negative Pressure Regulating Range: 0.02MPa~limit negative pressure
- Suction Rate: >15L1min (760mmHg)



# ENDOSCOPY

Latest technology and innovation

## EPX-2500Series



The new standard in high definition technology for cost-effective digital endoscopy. The standard in high definition technology for endoscopy. The new EPX-2500 is the processor of the first choice for standard procedures. It stands out for its unquestionable cost efficiency and thanks to its digital video output (DVI) it provides the physician with high-definition images without quality loss. For certain diagnosis and successful interventions.

- HD quality with digital interfaces
- Electronic zoom with up to 2x magnification
- Picture-in-picture function
- Simple operation
- Compatible with endoscopes in the 530 series and 270 series
- Patient information system for up to 44 individuals

## EPX-4450Series



The EPX-4450HD HDTV video processor offers top-level endoscopy in HDTV. Thanks to further enhanced image quality and optimized integration into the hospital network, it opens the door to a new world of diagnostic opportunities.

With an intuitive user interface, clear operating controls and diverse range of settings, the EPX-4450HD is an excellent video processor for both routine procedures and special clinical issues.

- Premium image quality thanks to HDTV electronics, CMOS and Super CCD technology
- FICE dual mode for simultaneously displaying white light and FICE images on the same screen
- On-board DICOM for seamless integration into the existing network
- Advanced workflow for intuitive and straightforward work processes
- An-blur function for documenting razor-sharp images
- XL-4450 light source with a powerful 300 W xenon lamp for optimal illumination

## EPX-3500Series



As a fully digital processor with Full HD1080p resolution, our latest EPX3500HD video processor provides a brilliant HD image quality according to the latest technology standard. With its network connection and digital DVI outputs, this processor is fully equipped to meet standard technology requirements.

- High definition images thanks to Full-HD output and Super CCD technology
- Three preset FICE patterns available
- Applicable to Full-HD wide monitors
- Applicable to USB storage device
- An-blur function for documenting razor-sharp images
- XL-4450 light source with a powerful 300 W xenon lamp for optimal illumination

## VME-2800 Imaging System



To provide image processing functions and figure and blood vessels enhancement functions which increases efficiency of clinical diagnosis of diseases.

- DVI Digital Signal
- Blood Vessels Enhancement
- 150W Xenon Lamp

*Auto White balance adjustment function.  
Image brightness and color adjustment function.  
Images frozen and picture in picture function.  
Figure and Blood vessels enhancement function.  
Peak and average metering light Shift function.*

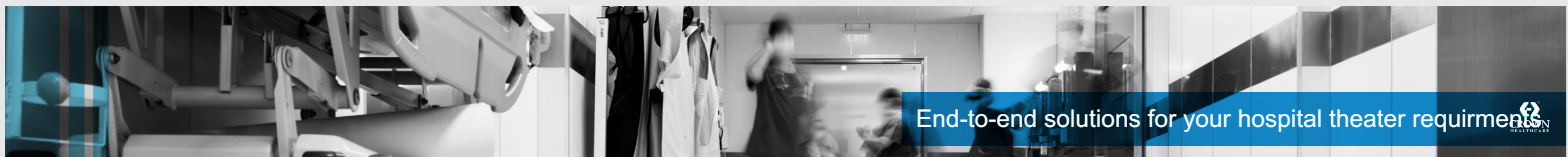

End-to-end solutions for your hospital theater requirements



# ENDOSCOPY

Lastest technology and innovation

## Aq100 Imaging System



AQ-100 equipped with high-resolution module (1280\*1024) and CBI capabilities to provide the best possible image quality for endoscopes. Enhancing the observation of capillaries and mucosal issues.

- (HBE) Hemoglobin enhancement
- (CBI) Compound Band Imaging
- Fully digital AQ SYSTEM processor
- Electronic magnification
- (ENH) Outline enhancement

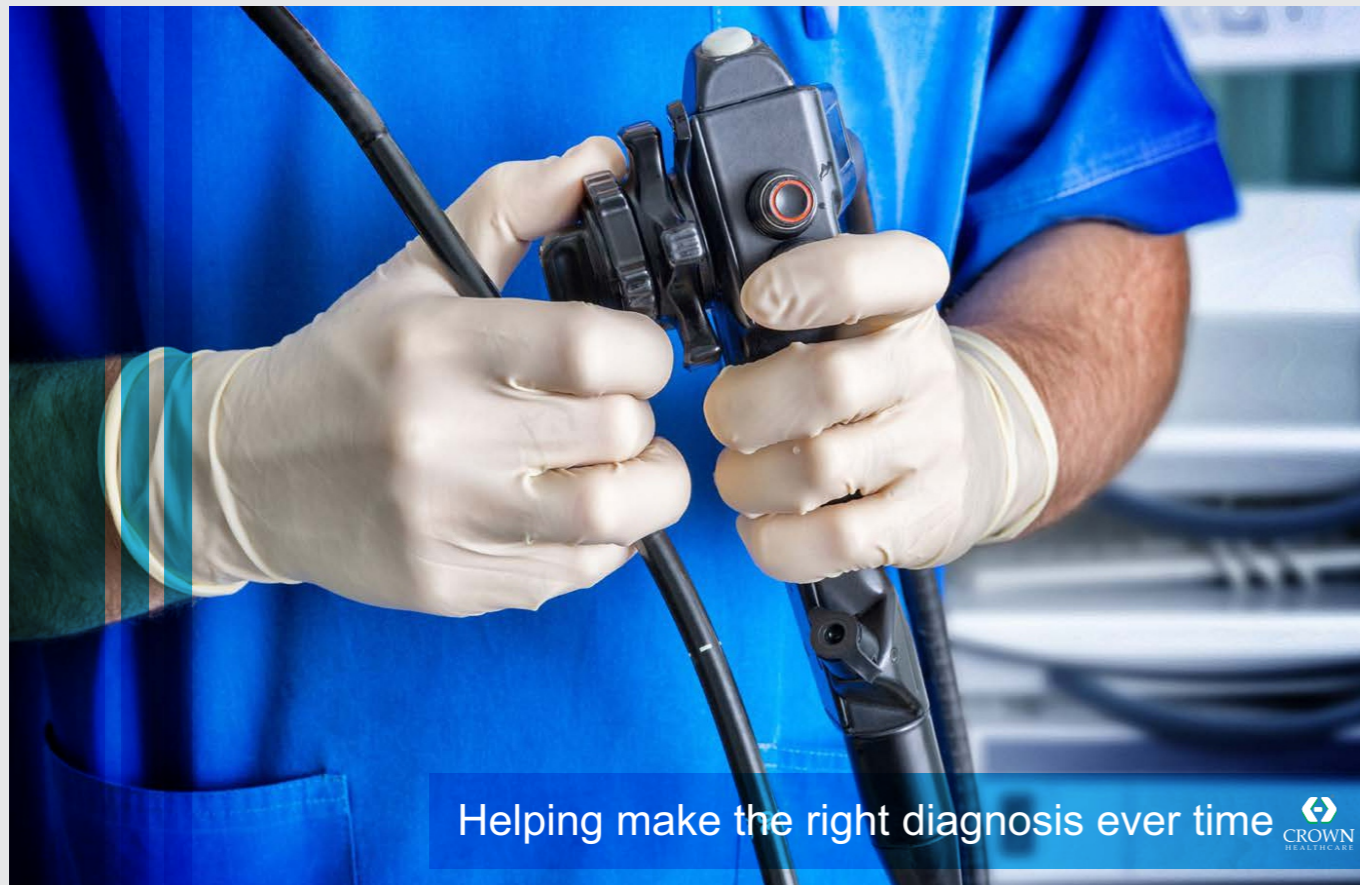

Helping make the right diagnosis ever time 



### ICU SOLUTIONS

- Patient Monitors
- Defibrillators
- Ventilators
- Syringe Pumps
- Infusion Pumps
- Pendants
- ECG Monitors
- Bbraun ICU/OR system

ICU SOLUTIONS



**BeneView  
T1/T5/T8**

Your Sophisticated Information Manager for Critical Care

**Optimized Visibility and Usability**

The high-resolution colour touch screen display offers exceptional visibility for all critical parameters. Customizable quick keys allow for direct access to every function.

**Improved Data Management**

Extensive data storage and management capabilities let caregivers conveniently review, export and manipulate all patient information. Advanced calculation tools provide effective diagnostic support.

**Advanced Information Platform**

BeneView features advanced connectivity options and can be quickly integrated with other patient monitors, the central monitoring system as well as with the HIS and CIS. Information can also be retrieved directly from other critical care devices, such as anaesthesia machines or ventilators.



**BeneView T1**

**Powerful Monitoring Functions**

With its wide range of monitoring functions, the BeneView T1 is suitable for patients at all levels of acuity. During transport, it also supports advanced parameters, such as PiCCO and EtCO2.

**Smart and Compact Design**

Weighing less than 1kg, the T1 is extremely compact and portable. The intuitive touch screen interface complies with the BeneView platform and simple to learn and operate. The display features automatic brightness control to ensure optimum data visibility under a variety of lighting conditions.

**Seamless Data Transfer**

The T1 guarantees the continuity of patient data during transport. When removed from the BeneView bedside monitor, the T1 automatically connects through Wi-Fi to the central monitoring station. All data collected during patient transport is synchronized when the T1 is connected again to a BeneView bedside monitor.



Consistent accuracy... everytime



Functional Patient Monitoring

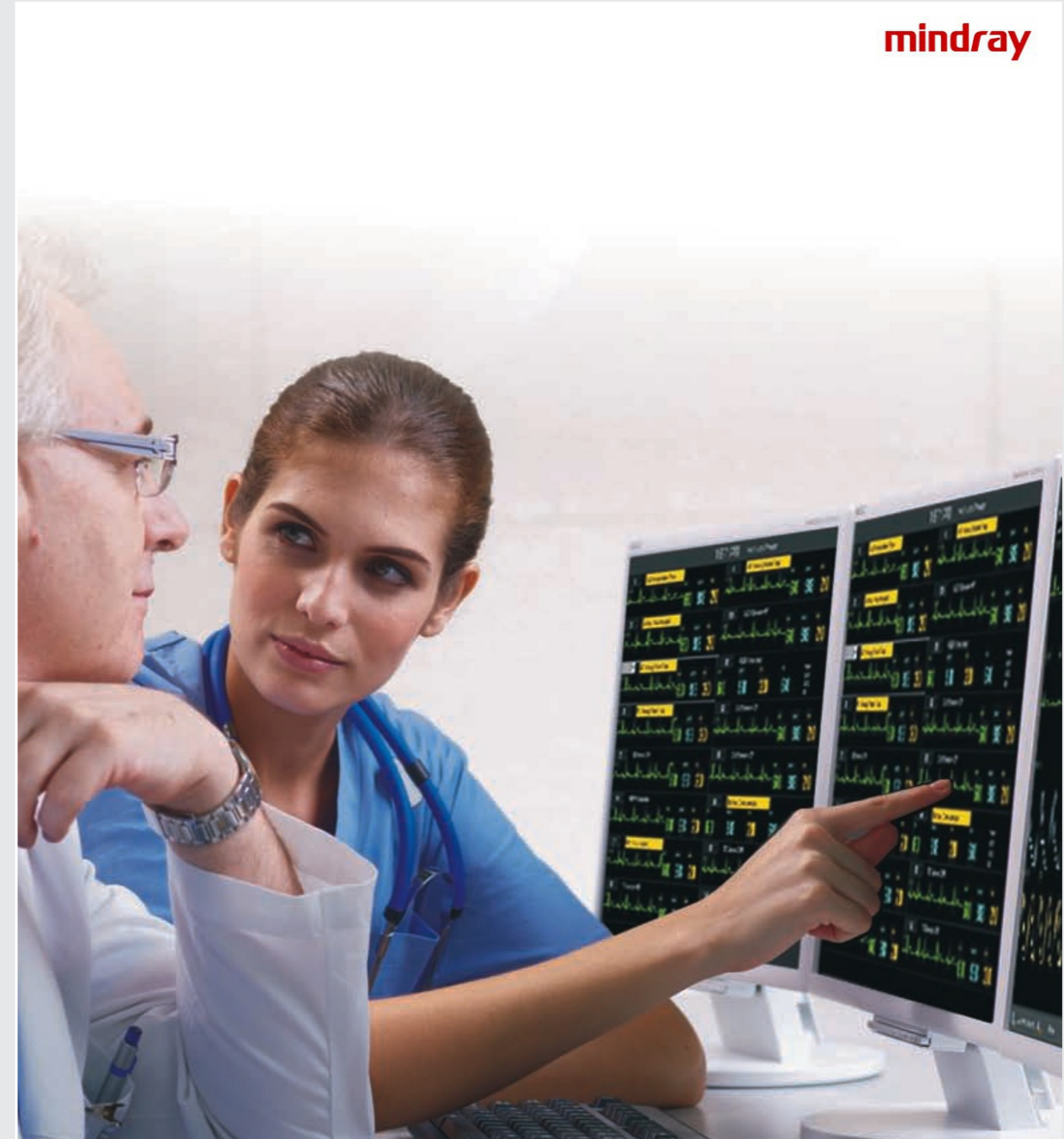

Central Monitoring System

**Powerful Networking Capability**

The Hypervisor VI, supports up to 32 bedside patient monitors in the standard configuration. The ADT module supports admission, discharge and transfer of patients while reducing the risk of transcription errors. The CMS Viewer function allows access to the patient monitoring system by the internet.

**Flexible and Adaptive Structure**

The system supports up to four displays and can be quickly adjusted according to the user requirements. Up to four remote displays and the CMS Viewer function allows clinicians view patient monitoring information when and where they want.

**Intuitive Operation**

Bi-directional controls between the Hypervisor VI and bedside monitors reduce clinician workloads and improve efficiency. The intuitive tabular menu is easy to learn and requires little training





## BeneHeart D3 & D6

### Key Features

- 4-in-1 design including monitoring, Manual Deib, AED, and Pacer
- All necessary optional Vital Sign monitoring functions integrated, making it convenient for emergency use without the additional need for a separate patient monitor
- Large and vivid display with 4 waveforms to ensure easy viewing of ECG and vital signs
- Compact design: easy to carry and easy to operate
- Deibrillation, synchronized cardioversion and AED with Biphasic technology
- Up to 360J escalating dose energy to maximize deibrillation success
- Powerful power capacity with batteries to support continuous long time monitoring and shocks during transport without external power supply.
- Powerful data storage, no worries about losing
- 1-2-3 steps to deibrillation, colour-coded buttons and highly visible patient data simplify manual deibrillation.
- Large, highly visible alarm lights advises caregivers a change in the patient's condition.
- Buttons for energy selection, charging and shock delivery improve ease of use for clinicians.
- Functions are accessed simply and quickly using rotary control and quick action keys.
- Lead selection button gives quick access to the optimum ECG waveform.
- Multiple power supply options enable the BeneHeart D3 to be used in a variety of locations.

## High performance, stable & accurate

### SV 300

**mindray**



#### E-series Ventilators - Mindray

The high-end user interfaces with quick access to all functions and settings.

#### Intelligent

Advanced modes, extensive parameter monitoring and weaning decision support procedures.

#### Versatile

Adapts to your physical and digital environment with several mounting options and comprehensive monitoring integration.

### Synovent E3



The SynoVent E3 has an advanced ventilator functionality as well as a user-friendly interface. Allowing the clinician to have instant control over the ventilator parameters and settings, the display can be configured to suit their needs. Enabling quick navigation of the SynoVent E3, a touch screen is combined with direct access knobs for this modern user interface. Two loops or three simultaneous waveforms can be displayed on the 10.4" screen, as well as 25 monitored parameters. Suitable for both adult and pediatric care, the innovative device is able to deliver tidal volumes ranging from 40 to 2000 ml. 12 ventilation modes can be supported.

### Synovent E5



SynoVent E5 is a modern instrument which is used as a ventilation system for patients. The highly technological advancement of the device allows interfacing according to the requirements of the patients which is simple and can be used easily. The settings of the ventilator can be controlled easily with the help of display screen. The screen is innovatively designed to meet the needs of the patients. The screen is capable of display 25 parameter that is monitored and also display 2 loops or 4 simultaneous waveforms. The touch screen technology in the display and direct access knobs help the user to quickly learn the functioning of the device which help the user to use the instrument more effectively for clinical purposes. The tidal volumes that are provided by ventilator have the range between 20-200 ml through which both the infant and adult are able to get the medical care through the instrument. 14 modes of ventilation is supported by the device.



High performance, stable & accurate

Optimum flexibility for hospitals and practices



- Comprehensive graphics and trending
- High-performance internal gas source technology
- Dual valve technology for precise breath delivery
- Pediatric through adult
- Invasive and noninvasive
- Transport ventilation support
- Easy to use touch screen user interface

- Low cost of ownership
- High-performance PSOL & active exhalation
- Comprehensive graphics & trending with event markers
- Infant through adult
- Invasive & non-invasive
- Feedback-controlled NCPAP & NCPAP+
- Intra-hospital patient transport
- Intranet and Internet remote viewing
- Outstanding Heliox Management



Consistent accuracy... everytime

## PORTABLE VENTILATORS

High performance, stable & accurate



### Vivo 30

To ensure a successful transition from hospital to home, healthcare providers seek solutions that can be trusted, make life easier and enjoy dedicated personal support. Moreover, serviceability and cost of ownership must meet increasingly strict demands.



### Vivo 40 with Target Volume

- For pediatric (>10 kg) and adult use.
- Target Volume stabilizes tidal volume delivery
- Appropriate for invasive and non-invasive use
- eSync feature for synchronized breath delivery
- Designed for use at Home or in the Hospital
- Large, easy-to-read display with simple menu structure
- Designed for a wide range of masks
- Offers 3 Ventilation modes, 2 Device modes, 2 Patient modes (adult/pediatric)
- Low noise <30dB(A)
- Extensive alarm package
- Internal 3 hour battery
- Integrated Heated Humidiier
- Internal data/calendar memory
- Stable device with small footprint
- Large, easy-to-use buttons with backlight
- Worldwide mains power compatibility
- Flexible DC power options

### Vivo 50



The Vivo 50\* Life-Support Ventilator combines high-quality technology with robust, premium Scandinavian design to provide excellent patient treatment in home and portable in various environments.

Thanks to the user-friendly configuration of pressure and volume regulated modes; the treatment can be personalized to the patient's needs. The Vivo 50 offers the possibility to use a leakage circuit when applying VCV (Volume Control Ventilation). This, together with eSync technology and a full range of settings, leads to a strong combination of performance and flexibility.



### BeneFusion SP1

**Friendliness**

- One hand operation" and intuitive keypad
- Compact and lightweight design for easy carrying
- Long run time battery, suitable for emergency and patient transfer

**safety**

- High accuracy: ±2%, satisfying neonatal use
- Fast start function against start delay due to friction
- Dynamic pressure detection, Anti-bolus
- IP24 water and dust protection, support cleaning with water

**connectivity**

- RS232, DC input, Nurse Call
- Wi-Fi connection available
- Dock support



### BeneFusion SP3

**Friendliness**

- One hand operation" and intuitive keypad
- Compact and lightweight design for easy carrying
- Long run time battery, suitable for emergency and patient transfer

**safety**

- High accuracy: ±2%, satisfying neonatal use
- Fast start function against start delay due to friction
- Dynamic pressure detection, Anti-bolus
- IP24 water and dust protection, support cleaning with water

**connectivity**

- RS232, DC input, Nurse Call
- Wi-Fi connection available
- Dock support

### BeneFusion VP5



- High accuracy performance ensures precise delivery
- Advanced SEMI-PRESS system
- Fast start fusion and DPS
- Anti-free-flow and Anti-bolus function
- 6 levels of air bubble detection
- History function and Drug library

### Pendants-Hyport Series

#### Hyport 8000 Motorized pendant with high-load capacity

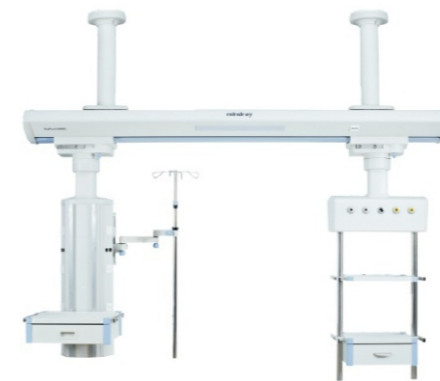

medical Supply Unit enables improved patient access, higher clinical efficiency and better patient care by lifting equipment of the floor, incorporating all kinds of outlets making them accessible.



### BeneFusion SP5 TIVA

the BeneFusion SP5 TCI is a syringe pump designed for intravenous anaesthesia.

The design of BeneFusion SP5 TCI combines all the advanced features as well as the powerful anaesthesia function in one single pump, which ensures the delivery of sedation and analgesics safely and perfectly as the anesthetist wished. The application of TCI pump has covered many clinical departments, including Induction Room, Operating Room, PACUs and ICU.

The professional algorithm ensures precise target concentration as the function of automatic drug compensation and titration, enabling the infusion continuously. Combined with the intuitive operation and display feature as well as the patient concern feature, further enabling the drug delivery safely.



### BeneFusion SP5 TCI

the BeneFusion SP5 TCI is a syringe pump designed for intravenous anaesthesia.

The design of BeneFusion SP5 TCI combines all the advanced features as well as the powerful anaesthesia function in one single pump, which ensures the delivery of sedation and analgesics safely and perfectly as the anesthetist wished. The application of TCI pump has covered many clinical departments, including Induction Room, Operating Room, PACUs and ICU.

The professional algorithm ensures precise target concentration as the function of automatic drug compensation and titration, enabling the infusion continuously. Combined with the intuitive operation and display feature as well as the patient concern feature, further enabling the drug delivery safely.



Comprehensive service contract only from CROWN HEALTHCARE

## HIGH performance and illumination

**OMRON**



### Electrocardiograph (ECG) Heart-scan

**Features and Benefits**

- Portable and compact.
- Direct review of results on clearly readable high-resolution screen with backlight.
- Cordless (no need to wear electrodes, no difficulties with cables)
- Very user-friendly.
- PC downloads through SD memory for 300 measurements.
- Low power consumption (works also with rechargeable batteries).
- Includes analysis software to inform the user directly on results with clear recommendation on the results.
- Device-menu selectable in 3 languages.
- (English, German and French)
- Optional: Card reader, ECG Viewer Software

**EDAN**



### SE-1200 Express 12-channel ECG

**features and Benefits**

- Large high-resolution colour touchscreen
- Alphanumeric keyboard
- One-touch operation
- Enhanced weak signal detection
- Comprehensive filters & anti-noise technology
- Real-time ECG waveforms freezing and review
- Advanced SEMIP algorithm for automatic measurements and interpretation
- Built-in high-resolution thermal printer with external USB printer (optional) support Extended printing
- Large internal memory, which can be enlarged by USB flash disk
- Built-in data management with reports review
- LAN/Wi-Fi(optional) connections
- Bi-directional communication with SE-1515 Data management System
- Multi-format reports export (optional)
- Barcode scanner support (optional)

### BeneHeart R12



- Stable, clean, and accurate ECG waveforms ensure the quality of ECG data and aid faster processing.
- Clear view of results helps you focus on diagnosis and care.
- Save up to 800 ECG records internally, or use the USB flash drive for online ECG storage and transmission.
- Lithium ion battery powers greater than 3.5 hours of continuous operation or 400-page recording on one charge.
- One of the lightest 12-lead electrocardiographs available – only 4.8 kg.
- Optional hardy and compact trolley for easy mobility and storage.

## ICU-/OR Systems

Infusion Pumps, Workstations, Accessories

**B | BRAUN**  
SHARING EXPERTISE

### B. Braun Space Managing Infusion Therapy



B. Braun Space is a modular infusion system that is small, light, and easy to use. The Infusomat Space volumetric pump and the Perfusor Space syringe pump are the basic building blocks of the Space system. Braun's "One Infusion System for all Therapies" approach, makes it possible to use one pump along the entire clinical pathway, for all hospital applications, setting the standard for clinical processes and patient safety.

- Small and light weight and easy to use
- Simplification through device standardisation
- Modular system supports tailor made solutions
- Promote patient safety with DoseGuard Dose Error Reduction Software
- Wired and wireless network connectivity for seamless integration.

### Perfusor® compact Syringe pump for use on all wards



**Flexibility and mobility**

**Performance data**

Infusion rates from 0.1 to 99.9 ml/h  
Volume pre-selection  
Stackable, with a built-in locking mechanism  
Battery operable for more than 3 days

**Features**

Automatic recognition of syringe size/fixation  
Automatic bolus reduction after pressure alarm  
Occlusion alarm pressure limits selectable: 0.3/0.6/1.2 bar

### Perfusor® compact S Syringe pump for pediatrics and neonatology



**Transportable infusion syringe pump**

For administration of fluids in nutritional therapy and infusion technique as well as for home care applications.

**Performance data**

Wide selection of syringes (from 2 - 50 ml) for higher flexibility  
Infusion rates from 0.01 to 200.0 ml/h  
Automatic calculation of the infusion rate based on volume over time  
Stackable with a built-in locking mechanism  
Battery operable for more than 3 days

**Features**

Automatic recognition of syringe size/fixation  
Automatic bolus reduction after pressure alarm  
Occlusion alarm pressure limits selectable: 0.3/0.6/1.2 bar  
Data Lock Function - keys are blocked

### Infusomat® fmS

Volumetric infusion pump for use with Intrafix Primeline IV administration sets:

**High operating convenience**

Direct input or automatic calculation of the delivery rates (volume over time)  
Large display to provide the most important parameters at one glance  
Ergonomic user interface for easy adjustments

**Safety features**

- Flow clamp prevents "free flow" when the pump door is opened
- Air detector minimizes the risk of air infusion
- Adjustable pressure limits result in shorter time to alarm in the event of an occlusion
- Original Infusomat®-Tubing ensures high delivery accuracy and consistency and, most important, trouble-free functioning over long periods of time



# ICU-/OR Systems

Infusion Pumps, Workstations, Accessories



## Original Perfusor® - Syringes

For use with the Perfusor syring pumps



### 3-piece syringe for infusion pumps

Original-Perfusor Syringe 20 ml

- Made of Polypropylene
- Highly transparent barrel
- High contrast graduation
  - Permanent markings
  - Ideal readability
  - Graduation in ml
- Centric Luer Lock cone for the attachment of a needle or for connection with other medical products (infusion tubing)
- Oval grip plate for better handling of the syringe and for prevention of rolling
- Safe plunger backstop to prevent unintentional withdrawal of plunger from barrel

## Original Perfusor® - Tubings

For use with the Perfusor syring pumps



- Luer Lock fitting enables compatibility to all pump syringes
- Pressure proof up to 2 Bar
- Type Standard is available in different lengths
- Type Opaque (black) offers light protection
- Type SafeSite® with BCV automates free-flow protection while the syringe is outside the pump
- Type Filter with 0,22 µm Sterifix® filter
- Type PCA with BCV for parallel infusion
- Always DEHP-Free

## Infusomat® Space Lines

For use with Infusomat Space & Infusomat fmS



- Silicone pump segment for high delivery accuracy and long-term consistency
- Parallel stripes indicate correct loading
- Different fastening clips on the lower and upper part of the silicone pump segment for easy and secure tubing guidance
- Additional set based anti-free flow clamp, automatically clamps the line whenever the tubing is removed from the pump
- Roller clamp with line holder and unique spike protector for safe disposal
- Different set design for different fields of application available
- Compatible with Infusomat® fm, fmS and Infusomat Space

## Braunostat® infusion stand

For stationary and mobile applications



- Holds up to three infusion pumps
- Height-adjustable (1260 - 2200 mm) infusion stand with hook holder for four infusion solution bags
- Drip collector for infusion sets
- Max. load 40 kp
- Mobile safety base with 5 castor wheels, 2 are lockable

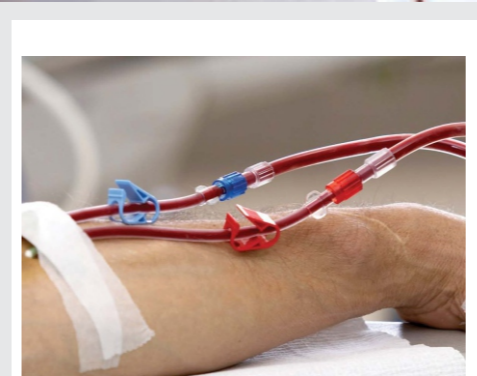

## RENALSOLUTIONS

- Dialysis Machine
- Reverse Osmosis Plants
- Consumable

RENAL SOLUTIONS





### ◀ SURDIAL 55Plus Dialysis Machine

Easy Handling Designed in Reliability and Safety with Innovative Technology

Specifications:

- 180 degrees turn able touch panel display
- Single needle system with one clamp
- UF, Conductivity profile
- Detection of micro air bubbles



### ▶ ROmedical BASIC Reverse Osmosis Plant

- Low budget reverse osmosis system
- High quality product water
- High operational reliability
- Cost-saving and economical RO water Purification
- Computer controlled
- Manually operated emergency mode in the event of PLC failure

### CONSUMABLES



Synthetic Hollow Fiber Dialyzer



Niprocart Bicarbonate Powder Cartridge



Acid Concentrate S-KF 5L



Nipro Bloodline A117/V687

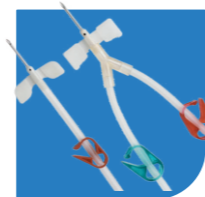

AV FISTULA NEEDLE  
Standard AVF - Single Needle  
AVF - 2 Pack



Citrosterile



Puristerile



Double Lumen Curved  
Double Lumen Straight

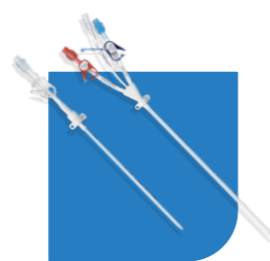

Triple Lumen Straight  
Single Lumen Straight

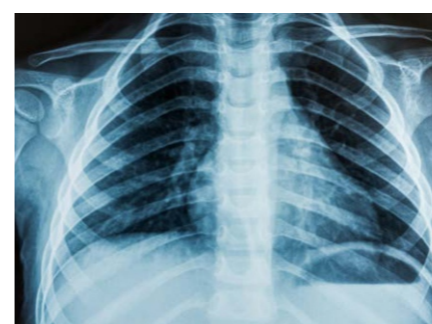

### IMAGING SOLUTIONS

- Ultrasounds
- X-ray Systems
- X-ray Printers
- X-ray Protection
- X-ray Accessories
- X-ray Consumables
- Ami X-ray Systems



IMAGING SOLUTIONS

# ULTRASOUND SYSTEMS

Visual clarity through innovation



**SonoScape** | Ultrasounds Portable

## S2 Ultrasound

- 15-inch high resolution LCD monitor with wide-view angle
- Standard PC keyboard, easy input
- Two probe sockets with probe holder, better protection for probes
- Rechargeable lithium battery, 1 hour scanning without power supply
- Abundant peripherals: DICOM3.0, VGA, video out, USB, S-Video, ECG module, Foot switch etc.
- B Mode, Dual B, 4B
- M Mode, Color M, Steer M, SonoScape S2 Front
- Color Mode, DPI Mode

- PW Mode, CW Mode (optional) Advanced Imaging Technology
- THI
- μ-Scan Speckle Reduction (optional)
- Compound Imaging (optional)
- Panoramic Imaging (optional)
- Trapezoid Imaging (optional)
- 4D imaging (optional)



## S8EXP Ultrasound

- LCD 15"
- Monitor angle adjustment
- 2 active probe connectors
- High density probes
- Scanning modes:
  - B, M, B/M, B/B, 4B
- High precision tissue harmonics
- ZOOM at real time and frozen state

- Ultrasound tomography mode
- TRAPEZOIDAL mode at linear probes
- MicroScan speckle reduction imaging
- Color Doppler mode
- Power Doppler mode
- Directional power Doppler mode
- Pulse wave Doppler mode
- Continuous Doppler mode
- Color tissue Doppler mode
- Pulse wave tissue Doppler mode
- Duplex and Triplex modes
- Steer M-mode
- Color M-mode
- Free Hand 3D mode
- 4D mode
- PANORAMIC mode
- ELASTO with quantitative evaluation
- STRESS ECHO mode

## S9 Ultrasound

**SonoScape** | Ultrasounds Portable



Modern technologies, innovative design and perfect imaging provide unlimited opportunities to the S9 system users.

- LCD 15"
- Monitor angle adjustment
- 2 active probe connectors
- Touch control panel
- High density probes

### Scanning modes:

- B, M, B/M, B/B, 4B
- High precision tissue harmonics
- ZOOM at real time and frozen state
- Ultrasound tomography mode
- TRAPEZOIDAL mode at linear probes
- MicroScan speckle reduction imaging
- Color Doppler mode
- Power Doppler mode
- Directional power Doppler mode
- Pulse wave Doppler mode
- Continuous Doppler mode
- Color tissue Doppler mode
- Pulse wave tissue Doppler mode
- Duplex and Triplex modes
- Steer M-mode
- Color M-mode
- Free Hand 3D mode
- 4D mode
- Panoramic Mode
- Elasto With Quantitative Evaluation
- Stress Echo Mode

## S12 Ultrasounds



- 15" high definition LED monitor with articulating arm
- Four transducer sockets
- A comprehensive selection of probes: Linear, Convex, Micro-convex, Endocavity, Phased Array, Bi-plane, Volumetric
- Premium application technology: μ-scan speckle reduction, Pulse Inversion Harmonic Imaging, Real-time Panoramic Imaging, Trapezoid Imaging, Auto-IMT, Triplex
- Full patient database and image management solutions
- DICOM 3.0, AVI/JPG, USB2.0, HDD, DVD, PDF report
- Built-in Battery



## A5 Ultrasound

- Digital B/W ultrasound
- 12" Adjustable LCD Monitor
- Portable weighs less than 6kg
- 2 Standard Transducer sockets holders
- Has backup battery
- M-Tuning one key image optimization
- 180° Transvaginal Probe
- Application Fields :
  - Radiology, OB/GYN, Vascular
  - Urology, Small Parts

### S22 Ultrasound



**SonoScape** | Ultrasounds Portable

- 18.5" high resolution widescreen LED
- 8" touch screen

**Premium application technology:**

I4D,  $\mu$ -scan, compound imaging, Pulse Inversion Harmonic Imaging, Color M-mode, Steer M-mode, PDI, TDI, Real-time Panoramic, Trapezoid, Auto-IMT, Stress Echo  
Full patient database and image management

**Solutions:** DICOM 3.0, AVI / JPG, USB2.0, HDD, DVD, PDF report

Multi-language Input Keyboard  
Mode B-mode, M-mode, THI, CDI, DPI, TDI, PW, CW, HPRF, 3D / 4D, Color M-mode, Steer M-mode, Panoramic imaging  
Scan format Linear, Convex, Micro-convex, Endocavity, Phased Array, Intraoperative, TEE, Bi-plane, Pencil, Volumetric  
Transducer inputs 4 + 1

### S40 Ultrasound



**S40 Technology and Elegance**

- 19 inch definition LCD monitor with wide viewing angle
- 10 inch touch screen with 15°adjustable angle
- Height and position adjustable control plain with muted function
- Five transducer sockets and additional one for CW probe
- Additional Endocavity probe holder and gel warmer
- **Full range of transducers:** Linear, Convex, Micro-convex, Endocavity, Phased array, Intraoperative, TEE, Pencil probe, Volumetric, Endocavity 4D and Laparoscope probe
- **Advanced application technology:** TDI, Stress Echo and Elastography
- **Full patient database solution:** DICOM 3.0, AVI/JPG, Dual USB, HDD, DVD, PDF report

### S50 Ultrasound



The design of s50 took operational use into consideration, creating a comfortable diagnosing environment. Ergonomic design, excellent man-machine interaction and rapid response, makes s50 an intelligent scanning assistant for you, bringing improved efficiency and helping to prevent fatigue from multiple examinations.

- 21.5 inches wide Led Monitor
- Super Responsive Touch Screen
- Flexible Adjusting Control Panel
- Built in Gel Warmer
- Wireless Wi-Fi Connection

## ACCESSORIES & PROBES

We have all the major probes



**Convex,Linear, Transvaginal, Cardiac,4D**



**SONY Ultrasound Printer UP897**



**Eco Supergel (Ultrasound Gel- Ceracarta Italy)**



**SONY Ultrasound Paper 110HG [Original]**



Quality Ultrasound Solution from. CROWN HEALTHCARE



# COMPLETE CR SYSTEM & DIGITAL SOLUTIONS



## FDR AcSelerate

Fujifilm's highest-class FPD system

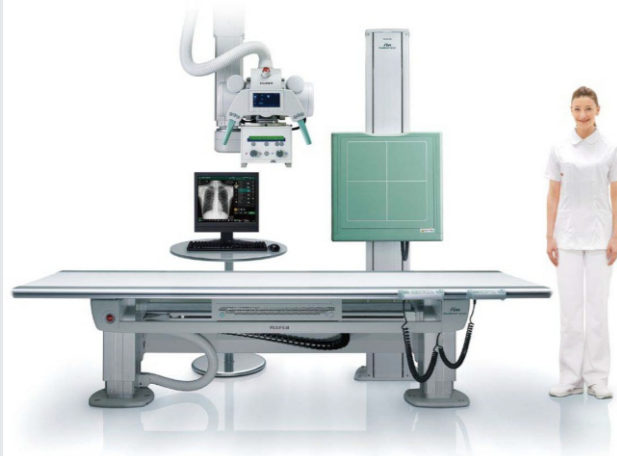

Digital radiography (DR) provides immediate imaging results for the operator, reducing the patient's waiting time. Our advanced DR products deliver productivity gains for radiologists and maximized image quality.

FDR AcSelerate, with its built-in ISS-Csl panel, performs high-speed processing. The panel offers the world's highest level DQE realized by Fujifilm's proprietary technologies, enabling patient-friendly exposures to be performed at a low X-ray dosage and superior quality images to be produced smoothly. Various options make more advanced image processing possible, helping radiologists perform effective diagnostic imaging.

- Tomosynthesis (optional)
- Energy Subtraction (optional)
- Image stitching function (optional)
- Flexible Cassete Traay (optional)

## FDR Smart f

ELEGANT & ECONOMICAL DIGITAL X-RAY SYSTEM



Fujifilm is proud to announce our latest high-quality cost-effective x-ray system.

Easily installed in limited spaces and easy to use, this user friendly system will bring upon a smart workflow for you.



Stripped down to the fundamentals, FDR Smart f will provide the essential functions you need.



## FDR Smart

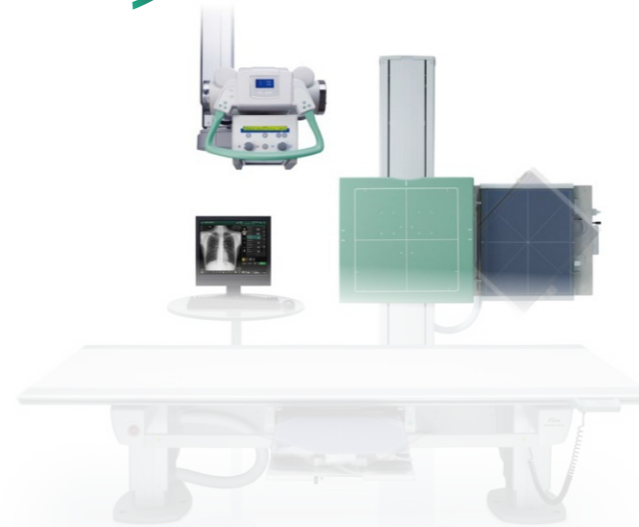

A ceiling mounted X-ray system available at a low cost

FDR D-EVO Suite, with the user-friendly design, offers auto-tracking of the table's vertical movement by X-ray tube as a standard function. The combined use with Fujifilm's console enables exposures to be smoothly performed. From Fujifilm's cassettes of different sizes and types such as wired/wireless, you can choose the best one for your purpose.

- No need to remove/reinstall cassettes to change orientation

## FDR GO

Fujifilm Mobile Solutions



Fujifilm offers various X-ray mobile systems. The first DR mobile X-ray system FDR Go, together with D-EVO series detectors, offers exceptional image quality. The FDR Go flex allows customers to transform existing analog mobile X-ray units into DR systems very easily.

FDR Go introduces mobile exams with Fujifilm's trademark image quality and dose performance.

- A reliable, high performing 32kW portable system
- Integrated Console Advance speed and ease of use
- FDR D-EVO detectors with Patented ISS
- Dynamic Visualization Image Optimization

At the bedside, in the OR, ED, ICU, NICU or anywhere in between, FDR Go is sure to bring smiles every step of the way.

## AMULET Innovality Mammography Solutions



AMULET Innovality – the result of Fujifilm's ongoing "innovation" and commitment to providing top "quality" mammography services. The Innovality utilises Fujifilm's unique a-Se direct conversion flat panel detector (FPD)\* to produce clear images with a low X-ray dose. This system makes use of intelligent AEC (i-AEC) combined with a new image analysis technology to automatically optimize the X-ray dosage for each breast type.

AMULET Innovality is a highly advanced mammography system which offers an extremely fast image interval of just 15 seconds. The model suitable for both routine & Stereo tactic biopsy examinations. Standard model pursuing greater usability & comfort routine mammography.

# FUJI FCR SOLUTIONS

## DIGITAL RADIOGRAPHY



### FUJI FCR PRIMA 12

Table-top type FCR image reader for clinics, boasting the fastest in its class processing speed



### FUJI FCR PRIMA TM

High-speed image processing tabletop FCR with mammography compatibility

Brand new world's smallest class all-in-one tabletop CR equipped with Mammography Image reading as standard.



### FUJI FCR CAPSULA XL II

Compact FCR image reader for hospitals which is suitable for mammography and other purposes, offering high throughput



### FUJI FCR XG5000

Digital radiography (DR) provides immediate imaging results for the operator, reducing the patient's waiting time.

Our advanced DR products deliver productivity gains for radiologists and maximized image quality.

A highly-efficient general-purpose FCR reader that offers superior quality images and comfortable workflow for medical staff.



# PRINTERS

## FUJI MEDICAL DRY IMAGERS



### FUJI MEDICAL DRY LASER IMAGER

## DRYPIX Plus

Model: DRYPIX 4000

DRYPIX Smart delivers superior quality images to satisfy various needs of multi-department hospitals. Despite its compact size, throughput is extremely high (80 sheets/h with 14"17" film) with high resolution of 508 dpi.



### FUJI MEDICAL DRY LASER IMAGER

## DRYPIX Plus

Model: DRYPIX 6000

The remarkably efficient DRYPIX Plus is designed as a centralized imager with a maximum of 3 film sizes. Features such as unrivaled image quality, network ability, & secured backup make DRYPIX Plus a welcome addition to any hospital department

**NEW**  
**FDR D-EVO II**  
The endless pursuit of high image quality



- Be smart - Fujifilm DR detector technology has evolved to be smart.
- Smart use of dose.
- Smart image processing.
- Smart Construction to withstand tough clinical environments.
- Smart design for easier technologist handling and patient positioning.
- Designed to be lightweight; only 2.6 kg\*with replaceable battery "14x17" model
- Loaded with internal memory that allows detector-only image storage.
- Antibacterial, waterproof and load resistant performance for peace of mind during use.
- LED indicators on detector edge confirm edges makes handling and patient positioning easy

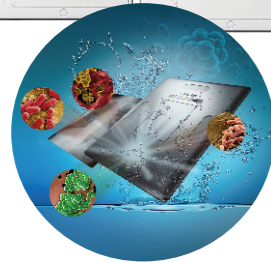

Coated with Fujifilm's HYDRO AG technology, his silver (AG)-based coating inhibits bacteria colonization by killing at least 99.99% of bacteria that come in contact with D-EVO II detectors

**WORK STATION**  
FUJI CONSOLE



**Console/Workstation**

The heart of the FDR / FCR systems assuring smooth workflow to a variety of facilities ranging from hospitals to clinics

**Console Advance/CR Console**

The Console Advance and the CR Console perform digital imaging processes – patient identification, image preview, processing, printing and storage, with DICOM interfacing. This high resolution console also uses a touch-panel screen with intuitive user guidance menus which are easy to use.

And then being a PC-based image processing system, they connect with various and multiple FDRs and FCRs over the network with DICOM interface for easy connectivity with other network devices.



Digital Imaging Remastered



**Synapse**



**Synapse®** Workstation software is the multi-modality Picture Archiving and Communication System (PACS) software for Synapse PACS.

**Fujifilm's** medical imaging and information management system allowing effective filmless diagnosis with high quality image processing

**WORK STATION**  
FUJI CONSOLE



Lead Apron



Gonad /Thyroid Shield



Lead gloves



Viewing Boxes



Xray Cassettes With Screen

- Size 18 x 24 Each
- Size 24 x 30 Each
- Size 30 X 40 Each
- Size 35 X 35 Each
- Size 35 X 43 Each



Screen Protection

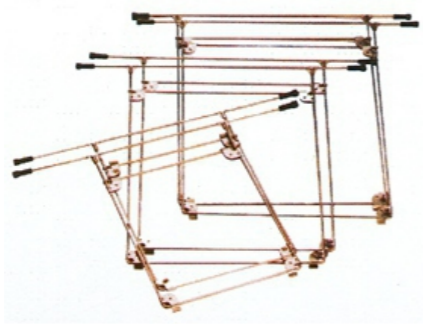

x-ray hangers

- Lead Apron
- Lead Gloves
- Thyroid Shield
- Gonad Shield (Set of Three)
- Lead Protection Screen 3 x 6 Feet
- Fim Markers Complete Set
- Safe Light
- Lead Glass 80 x 100 cm (8MM)
- Lead Glass 35 x 35 cm (8MM)
- Lead Glass 22 x 22 cm (8MM)
- Lead Sheet 4 X 6 Feet Each
- Viewing Boxes Single Each
- Viewing Boxes Double Each



Safe Light



Lead Sheet

## FUJI FILM & SCREEN SYSTEMS

FUJIFILM

### Films & Screen Systems

Digital radiography (DR) provides immediate imaging results for the operator, reducing the patient's waiting time. Our advanced DR products deliver productivity gains for radiologists and maximized image quality.

### Super HR-U



Super HR-T is a new high-contrast, high-resolution film for general radiography that provides consistently superb image quality. Super HR-U is a practical all-round film for general applications



### Fuji Medical Dry Imaging Film DI-ML

The high quality DI-ML films contribute to produce clear images on the "DryPix series" DRY Laser Images. These films have neutral color tones that produce images comparable to those made by wet processing.



### Fuji Medical Dry Imaging Film DI-HL

DI-ML is a premium Dry Imaging Laser Film that is dedicated for mammography. It has a D-max of 4.0, bluer film color, and better sharpness compared to DI-HL. Applicable for "DryPix series" DRY Laser Images.

#### AVAILABLE SIZE AND QUANTITY

Film Size	Quantity per package
35 x 43 cm (14 x 17 in)	100 sheets + 1 protective sheet
26 x 36 cm (10 x 14 in)	150 sheets + 1 protective sheet
25 x 30 cm (10 x 12 in)	150 sheets + 1 protective sheet
20 x 25 cm (8 x 10 in)	150 sheets + 1 protective sheet

## ALL PURPOSE MEDICAL DIAGNOSTIC X-RAY EQUIPMENT



### LX Series Line Frequency X-Ray Machines 300/500mA (LX30/50)



- These units come with various combinations of Tube Stands and Bucky Tables.
- Tubes Stands :
  - Floor to Ceiling (STN)
  - Ceiling Free Stand (CF)
  - Floor to Ceiling with Semi-Auto Film Device (STN-SFD)
- Tables with Bucky Grids :
  - Horizontal Bucky Table (Medflat)
  - Horizontal Bucky Table with Floating Table Top (Medfloat)
  - Motorized Bucky Table (Mototilt)
- These Special Purpose X-Ray units are perfectly suitable for use with Image Intensifier Systems. Various configurations consist of: -9" (Triple Field) I.I.TV System.
- The above combinations are available with various options like:
  - 17" High Resolution Monitors with image rotation facility.
  - Image Memory units.

PARAMETERS	LX - 30	LX - 50
Output	30 KW	40 KW
Max. mA output	300 mA	500 mA

OTHER PARAMETERS FOR LX - 30 / LX - 50	
<b>KVP (Radiography)</b>	40-125 KVP (In step of 1 KVP each)
<b>KVP (Fluoroscopy)</b>	45-100 KVP (In step of 5 KVP each)
<b>Timer (Radiographic)</b>	0.01 to 5 seconds (in 24 steps)
<b>Timer (Fluoroscopic)</b>	Cumm. Timer of 5 minutes
<b>Fluoro mA</b>	Upto 3mA
<b>Electronic overload</b>	Simultaneous protection from excess selection of mA, Time, KVP & input voltage
<b>Voltage Compensators</b>	For input voltage variation
<b>Tube Head with Collimator</b>	Rotating Anode, X-Ray Tube unit
<b>H.V. Cables</b>	One Pair of High Voltage Cables of length 8 mtrs. (Diff. Lengths Available on Request)
<b>Compatible Tube Stands</b>	Floor to ceiling (STN). Floor to ceiling with SFD (STNSFD). Ceiling Free Stand (CF).
<b>Compatible Tables</b>	Medflat, Mototilt, Medfloat.
<b>Power Supply</b>	(400-440V), (50, 60 Hz), AC ± 10%, 3 Phase As per voltage / frequency available.

### RF TABLE (with Automatic SFD)



#### COMPONENTS OF AN EFFICIENT SYSTEM

RF TABLE (with Automatic SFD)	
Table tilting movement	+90° / -23°
Tilting Speed (Motorised)	4° / s
Table Top Transversel movement	220mm ± 10mm, 22mm / sec. Motorised
Tube Longitudinal movement	740mm ± 10mm, 40mm / sec. Motorised
Maximum Load on Table Top	200 Kg.
Compression force (CUP)	78N - 98N
Distance between Table Top & Film	90 mm
Grid Movement	Oscillating
Dimensions (in mm)	2106 (L) x 1355 (W) x 900 (H)
Lead Shutter	2106 x 622 x 6 (table top size)
Compatible Cassette Size	Integrated 35 cm x 43 cm (14" x 17") 2193 (height of RF table in vertical position)

#### X-RAY TUBE

- Rotating Anode, Dual Focus with Geared / Automatic Collimator

#### IMAGING SYSTEM

- Image Intensifier of 9" / 12".
  - CCD camera for optimal picture quality.
  - 2 nos. 17" monitors.
  - DIP-IQ Memory.
- (Optional : 1K x 1K complete video chain)

#### HF X-RAY GENERATOR

- Output Power (Max.) : Options of 50/50/65/80 KW generators based upon requirement

#### OPTIONAL

- Elevating table top (vertical movement).

### HX SERIES (Remote Controlled RF Table) :

AMI remote controlled RF Table combines flexibility with advanced engineering thereby setting new standards for diagnostic image quality in order to provide practitioners with an executive diagnostic tool and thereby making the task easy, effortless and hygienic for both patient and practitioner with host of special features.



#### Special Features

- Wide Application Rane
- Barium Enema
- Gastro-Intestinal
- Barium Bolus Screening
- Various Iodine and Vascular procedures to
- Radiography (using an additional ceiling suspension tube).
- Various other life saving procedures.
- All movements of RF table are remote controlled from the console panel.
- DICOM compatible.
- Various attachments ccan be fed on table.
- Front loading of cassettes.



RF Table Control Panel

X-Ray Generator Control Panel

### LX 8R MOB



Spring Balanced Mobile (SMB) X-Ray, 100 mA With rotating anode tube.

**MA Range** 100: mA

**Power Output:** 8 KW

**Type of Anode:** Rotating Anode

**Stand:** SMOB (Spring Balance Mobile Stand)

**Power Supply:** Single Phase, AC supply.



Providing All your Imaging Solutions



# MAGNETOM SYMPHONY

## WITH POWER-CLASS

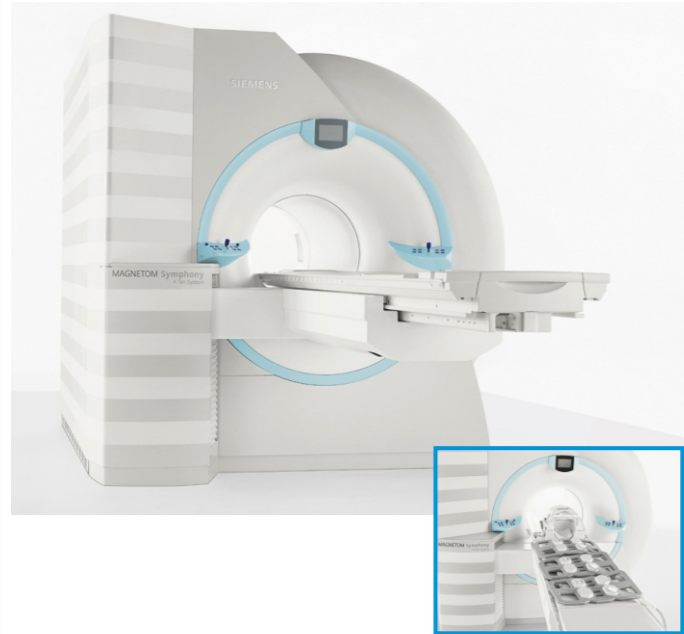

### MAGNETOM®

More power to you.

MAGNETOM® Symphony® and Tim (Total imaging matrix) technology - a perfect combination of patient-friendliness and fast scanning capabilities.

- 1.5T, 60-cm MR system incorporating Tim technology
- Available in an 18- or 32-channel configuration
- Expands upon the Symphony applications, adding additional inline processing such as Inline Diffusion or automated ADC mapping
- Nine Tim application suites standard, including cardiac, pediatric, and breast
- Fully integrated coil design
- Lightweight (patient-friendly), scalable coils part of the standard configuration

### The Siemens Sensation 16



The Siemens Sensation 16 Slice CT is one of the most widely-used multi-slice, whole-body CT scanners on the market. With the ability to perform 3D whole body and cardiac exams with exceptional image quality, the Siemens Sensation 16 is an excellent choice for imaging centers without the budget to buy new.

The Siemens Sensation 16-Slice CT matures Real time MPR CT Angio, 2D Post Processing, 3D Display, Syngo Shaded Display (SSD), Volume Measurements, and Volume Rendering Technique.

#### Technology

- 42 Second Rotation Speed
- Dura Akron Tube – 5.3 MHU
- Navigator Console
- Wizard Work Station
- 18" Flat Screen Monitors
- Air Cooled System
- Syngo User Interface

#### CARE:

- CARE Filter,
- CARE Topogram,
- CARE Bolus,
- CARE Dose



Complete Imaging Solutions from...



LABORATORY SOLUTIONS

### LAB SOLUTIONS

- Chemistry Analyzers
- Hematology Analyzers
- Electrolyte Analyzers
- Glucometers
- Coagulation Analyzers
- Microscopy
- Incubators
- Immunoassay
- Centrifuges & Roller Mixers
- Water Baths
- Safety Cabinets
- Hot Air Ovens
- Pipette & Balances
- Ortho Clinical Diagnostics
- Urine Analyzers

# URINE ANALYZER

Efficient urinalysis testing

## U120 Urine Analyzer



- U120 Urine Analyzer is a high quality & competitively priced system developed for accurate & efficient urinalysis testing.
- Up to 120 tests/hour at Continuous Test Mode
  - Allows analysis of urine specimens quickly
  - Also available with 40 tests/hour at single test mode
- Minimal Training Required
  - Automatic calibration and easy to operate
  - Audible beep signals the operator when to dip the strips in urine
- 500 Memory Storage
  - Saves and recalls the last 500 records automatically
- Reliable strips available for analyzer and visual reading
  - 8, 9, 10, and 11 parameters available for analyzer reading



## U500 Urine Analyzer

Accurate and Efficient, Up to 500 tests/hour for medium/large volume sample testing. Test categories include Routine, STAT, and QC

- **Easy to Operate**  
Large touchscreen LCD offers simple menu navigation
- **Convenient**  
Automatic calibration and waste disposal reduce hands-on time. Can read strips with up to 14 parameters, including Microalbumin/Creatinine/Calcium Strip selection of up to 4 combinations for analyzer reading
- **Data Management Capability**  
RS232C port for easy data transfer to an external computer or LIS. Record Operator/Patient ID by manual entry or Barcode Reader
- **Unique Lockout Functions**  
Strip Lockout • User Lockout • QC Lockout



Accurate testing every time

# Mission® Plus Hb Hemoglobin Testing System



Mission® Plus Hb Hemoglobin Testing System provides Lab-quality accuracy and precision for Hb and Hct testing!

- Unique and Deluxe Design
- Quick
- Accurate
- Convenient



Global Diagnostics for Local Markets™

## On-Call Plus

Blood Glucose Monitoring System

Visit/Call Us For:

- On-Call Plus Starter Kit
  - On-Call Ez Starter Kit
  - On-Call® Plus Blood Glucose Test Strips
  - On-Call® Plus Lancets
- And Many More



1µL Blood Sample

Full Kit

# MICROSCOPES

## Upright Microscopes



### Olympus CX23

High-performing, quality optics include a quadruple nosepiece equipped with Olympus' plan a chromat objectives ensuring a wide field of view with a field number of 20. The objectives maintain superb image flatness throughout the field of view and long working distances supported by a focus lock to prevent objectives and specimens from damage. An LED light source provides both a long service time of 20,000 hours and lower power consumption while the reduced blue light preserves vivid colour observation on HE staining



### Olympus CX31

**For Teaching & Routine Application**

The CX31 is a fixed specification binocular microscope for teaching & routine applications. It offers a rigid & durable construction with high performance & long life time. The optics provide bright & even images & adapters allow mounting of Olympus digital cameras for easy & efficient digital imaging



### Olympus BX53

**The researchers' choice for quality, performance, & application flexibility.**

**Key Features:**

- Suitable for bright field, darkfield, phase contrast, Nomarski/DIC, polarised light and fluorescence applications.
- 8 Position fluorescence illuminator (accepts Cool LED excitation systems)
- Unique Fluorescence Illumination with fly-eye optics
- Upgrade able with motorised components
- Magnification and filter read-out to cellSens software
- Ambidextrous operation Eco mode



### Olympus BX63

**The automated microscope system for high-end fluorescence imaging.**

**Key Features:**

- Most accurate motorised Z-drive
- Highest stability due to fixed stage design
- Highly precise ultra-sonic stage
- Unique operational concept
- Unmatched workspace personalisation
- Full control via touch panel controller
- Detachable manual controller
- Intuitive contrast management
- Compatible with CoolLED fluorescence excitation systems

## Inverted Scopes



### Olympus CKX31

**Compact inverted microscope for routine use.**

**Key Features:**

- Suitable for bright field, phase contrast and relief contrast
  - **Observations**
  - UIS2 Advanced optical system
  - Easy operation and transport
  - Multifunctional stages
- Very best in it's class of microscopes



### Olympus CKX41

**The compact inverted microscope for routine use.**

**Key Features:**

- Suitable for bright field, phase, relief contrast and fluorescence
- **observations**
- Outstanding flat images
- Enhanced image clarity
- Cost-effective

Very best in its Class



### Olympus BX43

**world renowned UIS2 optics and operating efficiency for a wide range of clinical applications.**

**Key Features:**

- True colour LED illumination
- Various contrast methods
- Light Intensity Manager
- Upgrade able with motorised components
- Magnification and filter read-out
- Digital imaging platform for a wide range of camera systems



### Olympus CX 41

**The Budget CX-41 System**

Consists of a CX-41 Olympus microscope with 30W light source, 10X and 100X dark field objectives, phase contrast/dark field/bright field condenser, Watec-231S2 colour camera, Live Blood Capture software and video capture card for Windows XP/Vista/7/8



### Olympus BX46

**Specialized for clinical screening.**

**Key Features:**

- Unrivalled ergonomomy
- Ultra low fixed stage
- World's first tilt, telescopic, lifting tube
- Light Intensity Manager
- True colour LED illumination
- No condenser changes from 4x to 100x



# MICROSCOPES

Inverted scopes



**Olympus LX53**  
Microscope (LX3 series)

**Key features**

- Suitable for fluorescence, phase, relief contrast and brightfield microscopy
- Fluorescence turret for up to 8 filter cubes
- UIS2 infinity corrected optics
- Pre-centered phase contrast optics
- Choice of 30W or 100W illumination pillars
- Range of LWD condensers available
- Cost effective



**Olympus LX73**  
Inverted Microscope (LX3 series)

**Key features**

- High speed filter wheels, shutters and light sources
- The Olympus U-RTC, Real Time Controller allows for microsecond timing accuracy..
- The new fly-eye fluorescence illuminator for uniform fluorescence across the field.
- The ultrasonic motorized, encoded stage provides precise and repeatable movement.

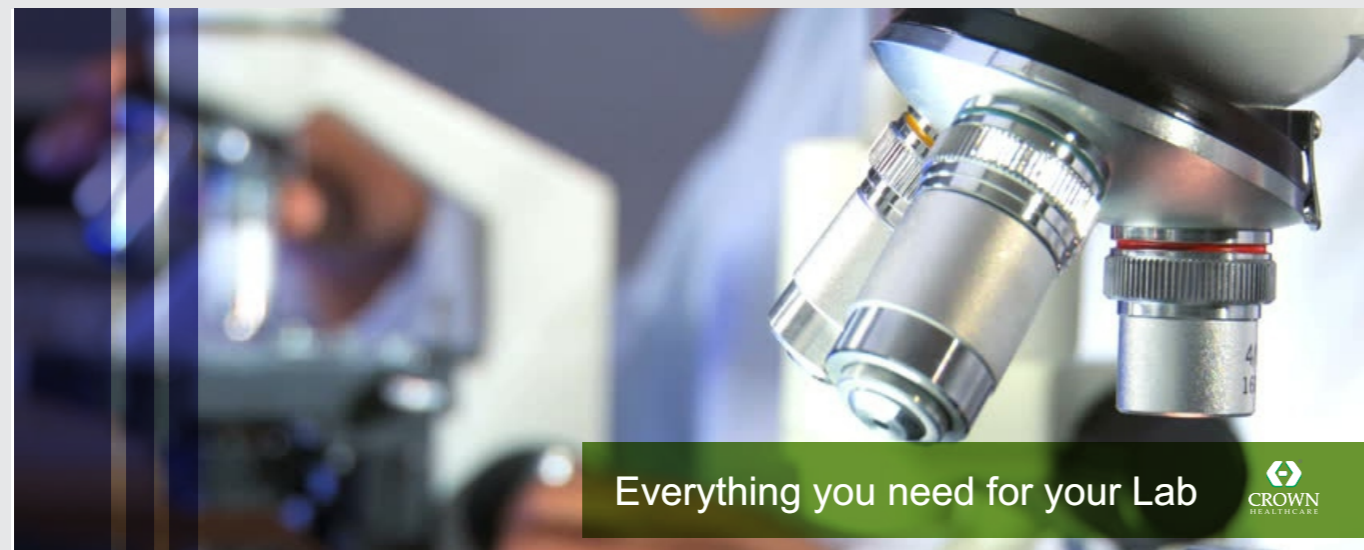

Everything you need for your Lab



## Stereo Zoom Scopes



**Olympus Sz61**

Full featured stereo microscope.

**Key Features:**

- Wide variety of lighting systems, stands and accessories
- Unique LED integrated illumination stand
- Top zoom performance
- Ready for digital camera adaptation



**Olympus SZX10**

Advanced routine stereo zoom microscope.

**Key Features:**

- Resolution of 600 LP/mm
- High Numerical Aperture (0.2)
- Maximum magnification (126x)
- Large Field of View (69.8 mm)
- Long Working Distance (171 mm)
- Easy to use fluorescence illuminator

For teaching & consulting

**Bx53 Multi-Observer**

Multi-observer microscope



Ideal tool for teaching and consulting

The BX53 multi-observer microscope allows up to ten users to observe the same specimen with their own eyepiece.

The image viewed is not a digital representation & therefore users receive an authentic viewing experience that is ideal for training purposes or to facilitate collaboration between colleagues.

Benefit from Olympus' optical expertise

Optically ahead of the curve

The UIS2 optical system built on the Bx53



When precision is everything



# MICROSCOPES

Biological Microscopes



## XSZ 107BN Biological Microscope



**Product Description:**

With Classical Shape, XSZ-107BN series microscope has been popular for 30 years.

**Specification** Viewing Head: Sliding Binocular Head Inclined at 45° 360° Rotatable

**Eyeiece:** Wide Field Eyeiece WF10× / 18 Wide Field Eyeiece WF16× / 11

**Objecti e:** Achromatic Object e 4× \10× \40× \100×

**Nosepiece:** Quadruple Nosepiece Stage: Single Layer Mechanical Stage 140× 140mm/ 75× 50mm

**Condenser:** Abbe NA1.25 with Iris Diaphragm & Filter Built-in Illumination: Halo en Lamp 6V/ 20W

Plan-concave Mirror

**Filter:** Blue Filter Green Filter

# CENTRIFUGES

WATER BATH



## NF 200

### Bench Top Centrifuge

- Maximum Capacity : 12x15 ml
- Maximum Speed : 5,000 rpm
- Maximum RCF : 2.822xg
- Programmable microprocessor control system.
- Digital displays for time and speed / RCF (xg).
- 1 - 99 minutes timer with hold position.
- Epoxy-polyester powder coated steel chamber.
- Pulse key.
- Quiet, direct drive, brushless induction motor.
- Motor over heating protection.
- Ventilation system for minimum temperature increase in the chamber.
- Lid lock.
- Delivered with 12x15 ml Angle rotor made of polypropylene.
- Adaptors for 1,5/2 ml, 5 ml and 7 ml tubes.



## NF 048 Microlitre and Haematocrit Centrifuge

- Maximum Capacity : 24x1.5/2 ml 24x capillary tubes
- Maximum Speed : 14,000 rpm 12,000 rpm
- Maximum RCF : 18,188xg 14,811xg
- Programmable microprocessor control system.
- Digital displays for time and speed / RCF (xg).
- 1 - 99 minutes timer with hold position.
- Epoxy-polyester powder coated steel chamber.
- Pulse key.
- Quiet, direct drive, brushless induction motor.
- Motor over heating protection.
- Ventilation system for minimum temperature increase in the chamber.
- Lid lock.
- Choice of 24x1.5/2 ml Angle Rotor and 24x capillary tube Haematocrit Rotor.
- Adaptors for 500/800 µl, 200 µl PCR, 250/400/700 µl.



Everything you need for your lab



**NF 400-NF 400R**  
**Medium Capacity**  
 Bench Top Centrifuges



- Angle Rotor Swing-out Rotors**
- Maximum Capacity : 16x15ml 4x100ml 2xM.Plate
  - Maximum Speed : 4,100 rpm 4,100 rpm 4.100 rpm
  - Maximum RCF : 2.142xg 2.819xg 2.011xg
  - Programmable microprocessor control system.
  - Digital display for time and speed / RCF (xg).
  - Digital display for temperature for NF 400R.
  - Programmable relative centrifugal force (RCF).
  - Electronic imbalance detection system.
  - Stainless steel chamber.
  - 1 - 99 minutes timer with hold position.
  - 5 acceleration / 5 braking rates.
  - Lid lock.
  - Powerful, quiet, and maintenance free induction motor.
  - Minimum temperature increase in the chamber by means of ventilation system for NF 400.
  - Temperature control between -9°C / +40°C for NF 400R.
  - Motor over heating protection.
  - Wide range of accessories to accommodate most manufacturers' tubes and microtitre plate.
  - Totally CFC free refrigerant fluid and insulation material for NF 400R.



**Bench Top Centrifuges**

**Water Bath**

**NB 5/9/20 Unstired**  
**Water baths**



- Three different useful volumes : 4, 7 and 15 liters.
- Temperature range: Ambient temperature + 5°C / 99.9°C
- Designed for many general and special applications in microbiology, research and industrial laboratories.
- Excellent temperature control of liquid by programmable
- PID microprocessor control system.
- Highly visible dual display for temperature and time.
- Delayed start time.
- Seamless stainless steel tank for easy cleaning.
- Excellent temperature uniformity and stability by triple insulation.
- Footprint almost equal to the working area to save bench space.



End-to-End Laboratory Solutions



**CENTRIFUGES**  
**WATER BATH**



**OMEGA 6**  
**CENTRIFUGE MACHINE**



**Product Description**

It has the advantages of small cubage, lightweight, large capacity, low noise and so on. It can be operated conveniently. It is an ideal instrument for hospitals, labs to make qualitative analysis to serum, plasma, radio-immunity.

- Power Supply: AC 220V/110V 50Hz/60Hz
- Max speed: 4000rpm
- Capacity: 20ml\*6(angle rotor of 45degree)
- Max rcf: 1790xg
- Timer: 0-60min
- Overall size: 275× 245× 235mm
- Motor power: 40W

**OMEGA 12**  
**CENTRIFUGE MACHINE**



**Product Description**

It has the advantages of small cubage, light weight, large capacity, low noise and so on. It can be operated conveniently. It is an ideal instrument for hospitals, labs to make qualitative analysis to serum, plasma, radio-immunity.

- Power Supply: 220V 50Hz
- Max speed: 4000rpm
- Capacity: 12X20ml
- Max rcf: 2325xg
- Timer: 0-60min
- Noise: <75dB
- Motor power: 135W



**OMEGA 20**  
**CENTRIFUGE HEMACRIT 120**

**Micro Hematocrit Centrifuge is for measuring specific product values of blood cell and separating micro blood and solution. High speed and efficient, safety lid lock.**

- Power Supply: AC 220/110V± 10% 50/60Hz
- Power output : 100W
- Max speed: 12000rpm, Fine brush motor
- Max RCF:15300xg, Disc rotor
- Timer: 0-30min
- Capacity: Ø1.5mm× 75mm(24capillaries)



**OMEGA 30**  
**HEMACRIT 120 II**

**Product Description**  
 Easy to operate, with large capacity, steady performance. Applicable for blood serum and plasma separation in laboratories.

- Specifications:**
- High-speed Centrifuge
  - Power Supply: AC 220V/110V 50Hz/60Hz
  - Max speed: 16000rpm
  - Capacity: 0.5ml\*12, 1.5ml\*12, 5ml\*6
  - Max rcf: 17000xg
  - Timer: 0-60min with hold function
  - Weight: 10kg
  - Motor Type: AC motor

# INCUBATORS

Excellent Condition for Biology & Microbiology

## EN 025/055/120 Incubators



- Three different sizes: 25, 55 and 120 liters.
- Temperature range: Ambient Temperature +5°C / 80°C.
- Excellent incubation conditions for the applications in biology and microbiology laboratories such as medical and veterinary fields; research & quality control examinations in pharmaceutical, food & cosmetics industries and biotechnology.
- Programmable PID microprocessor control system.
- User friendly control panel located on the door, including digital displays for temperature and time.
- Stainless steel interior for easy cleaning and decontamination.
- Air jacketed heating system and triple insulation for highly precise & constant temperatures.
- Very homogeneous temperature distribution by natural air convection: Minimum turbulence and no cross contamination.
- Frameless inner glass door for the observation of samples without any temperature drop.
- Safety thermostat as standard.
- Optional **NüveTherm™** data control software and RS 232 kit.



Range from 25,55 & 120 Lt

## EN 300/400/500 Incubators



- Three different sizes: 22, 44 and 120 liters.
- Temperature range: Ambient Temperature +5°C / 80°C.
- Excellent incubation conditions for the applications in all biology and microbiology laboratories such as medical and veterinary fields; research and quality control examinations in pharmaceutical, food and cosmetics industries and in biotechnology.
- Programmable PID microprocessor control system.
- User friendly control panel including digital displays for temperature and time.
- Delayed start timer.
- Anodic-oxidated aluminum chamber for standard models; stainless steel chamber for "P" models.
- Very homogeneous temperature distribution obtained by natural air convection for standard models and by forced air ventilation for "P" models.
- Frameless inner glass door for the observation of samples without any temperature drop.
- Safety thermostat as standard.

Ranges from 22,44 & 120 Lt

# LAB INCUBATORS



Laboratory equipments



1-52 Lab Incubator 53L PNP 9052



22L PNP 9022 Lab Incubator

# STERILIZERS

Excellent Uniformity & Stability

## FN 300/400/500 Dry Heat Sterilizers / Ovens



Range from 25,55 & 120 Lt

- Three different sizes: 22, 44 and 120 liters.
- Temperature range: Ambient Temperature +5°C / 250°C.
- Designed for sterilization, drying and heating purposes.
- Programmable PID microprocessor control system.
- Easy to use control panel including digital displays for temperature and time.
- Delayed start timer.
- Excellent uniformity and stability of temperature by high grade of insulation and microprocessor control system.
- Anodic-oxidated aluminum chamber for standard models; stainless steel chamber for "P" models.
- Very homogeneous temperature distribution obtained by natural air convection for standard models and by forced air ventilation for "P" models.
- Low temperature loss by means of the door pressing firmly and tightly against the chamber gasket.
- Outlet port for vapour exhaustion.
- Safety thermostat as standard.

# STERILIZER

Hygiene & Safety is Key



## OMEGA O25L

**Capacity:** 25L  
**Power:** 850W  
**Shelves:** 2(PCS)  
**Timing Range:** 1~9999min

### Product Description

The sterilizer takes advantage of high temperature disinfection principle, which destroys cell bioplasm, denatures protein and concentrates electrolyte to kill microorganisms.

### Features:

- Microprocessor temperature controller
- Rapid sterilization time
- Forced air convection
- Auto stop when temperature over limit
- Air inlet adjustment & timing control

### Specification:

**Electrical Requirement:** 220V 50Hz  
**Temperature Range:** RT+10~200°C/RT+10~250°C  
**Display Resolution:** 0.1°C  
**Ambient Temperature:** +5~40°C



## OMEGA 50L

**Capacity:** 50L  
**Power:** 850W  
**Shelves:** 2(PCS)  
**Timing Range:** 1~9999min

### Product Description

The sterilizer takes advantage of high temperature disinfection principle, which destroys cell bioplasm, denatures protein and concentrates electrolyte to kill microorganisms.

### Features:

- Microprocessor temperature controller
- Rapid sterilization time
- Forced air convection
- Auto stop when temperature over limit
- Air inlet adjustment & timing control

### Specification:

**Electrical Requirement:** 220V 50Hz  
**Temperature Range:** RT+10~200°C/RT+10~250°C  
**Display Resolution:** 0.1°C  
**Ambient Temperature:** +5~40°C



Quality products from..... CROWN HEALTHCARE

# DISTILLER & SAFETY CABINETS



## NS 103

### Economical Water Distiller

- Distilled water capacity: 3.5 lt / hr.
- Stainless steel heater.
- All surfaces in contact with water and steam made of stainless material.
- Manometer for inlet water pressure.
- Protection against empty boiling tank and water interruption.
- High efficiency even at low inlet water pressure.
- Wall mounted type, saving space in the laboratories.
- Easy and simple operation.

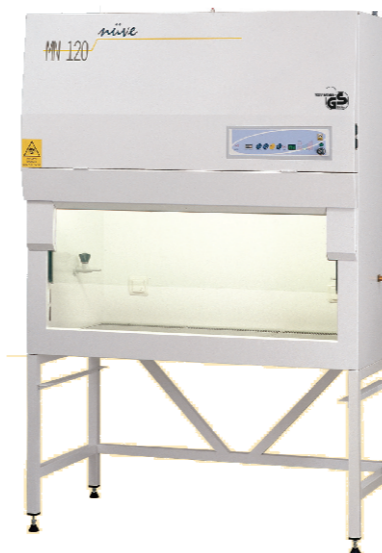

## MN Series Class II

### Microbiological Safety Cabinets

- Two models with different working table width: MN 090: 89 cm / MN 120: 119 cm.
- First class protection for operator, environment and product.
- Microprocessor control system with digital display for air flow speed.
- Two HEPA filters with 99.999 % efficiency for particles  $\geq 0.3 \mu\text{m}$ .
- Automatic speed compensation system against clogged filter.
- Mains power switch with key lock.
- Alarms for: Power failure, control system failure, open window, low and high air flow speed, clogged filters.
- Perfect air tightness of window seal by means of gas spring assisted window.
- Comfort of usage with very quiet blower and high light intensity.
- Smooth chamber walls and rounded corners without soldering for easy cleaning and decontamination.
- Stainless steel and removable 3 pcs. work table.
- DOP test inlet, elapsed time counter and 2 pc. power socket as standard.
- EN 12469 Certificate for MN 120



## LN Series Laminar Flow Cabinets

- Two models with different working table width: LN 090: 89 cm. LN 120: 119 cm.
- Designed for the applications with non-hazardous materials in particle free environment for complete product protection.
- Single piece working table made of stainless steel for easy cleaning and decontamination.
- Pre-filter with 85 % efficiency for particles  $\geq 0.5 \mu\text{m}$  ; HEPA filter with 99.999 % efficiency for particles  $\geq 0.3 \mu\text{m}$ .
- Microprocessor control system with digital display for air flow speed.
- Automatic speed compensation system against clogged filter.
- Audible and visible alarm for lower or higher airflow speed.
- Recirculated HEPA filtered air to prolong the lifetime of pre and HEPA filters.
- High light intensity and low noise level.
- Elapsed time counter and 2 pcs. power socket as standard.
- DOP test inlet.

# WATER BATHS

Stillers & Cabinets



## Lab Water Bath

**Specs:**  
**Separate:** Eight-hole  
**Power Supply:** 220V50Hz  
**Power:** 1500W  
**Temperature Range:** RT-95° C  
**Temperature Fluctuation:** ± 1.5° C  
**Temperature Uniformity:** 1.5° C

The product use imported stainless steel plate, cold rolled steel and other high-quality materials, and by electroplating polishing, paint and other craft elaborate. Temperature part of the use of electronic temperature control, temperature display directly display the actual temperature of the pot, with strong corrosion resistance, compact structure, handsome in appearance, economical and practical, energy saving, easy maintenance and long service life and so on.



## OMEGA WD1 Water Distiller

**Electric** 380V/50Hz  
**Supply Power** 7.5KW ≥  
**Water Discharge** 10L/h

**Performance and characteristic**

- Made of high quality stainless steel. Condensing coil structure, the cooling effect is good, large volume of water.
- Evaporative cooling water return barrel, save water resources.
- Release valve barrel condensed water can be discharged to improve fouling conditions.
- Copper immersion heating pipe, high thermal efficiency, long service life.

# BLOOD MIXER

Ideal Instruments for blood analysis



KJ-201BS | Oscillator

## OMEGA RM4 BLOOD MIXER

The Blood Mixer is specially designed for vacuum blood tube mixing. It is an ideal instrument of blood corpuscle analyzer and blood flow analyzer for full sample mixing in laboratories with high mixing efficiency & consistency.

**Main Technical Data:**

- Rolling Speed: 12-32 rpm
- Tube Qty per : 1-15 pc
- Tube diameter: Ø13±0.1mm
- Working Disc Diameter: Ø 220mm
- Angle of Inclination: 38°
- Voltage: AC220V±10% (50/60Hz)
- Power Consumption: 6w
- Working System: continue
- Safety Category: I series B type common device



## OMEGA SK-1 VORTEX MIXER

**Specifications:**

- Power Supply: AC 220V/110V 50Hz/60Hz
- Motor Power: 40W
- Speed: 0-2400rpm, Stepless regulation
- Rotating Head: Sponge head

Efficient & Consistent



End-to-End Laboratory Solutions



# COAGULATION ANALYZERS

Ideal Instruments for blood analysis

## C2000-4 Four Channel Coagulation Analyzer Semi-Auto

### Technical specifications

Measurement Principle: coagulation method (double magnetic circuit mechanical method)  
 Sample volume: 200-50ul  
 Reagent: 50ul-100ul  
 Measuring accuracy: ±3%  
 Incubating channel: 16/6/4  
 Reagent station: 5/3/2

### System configuration

C2000-4/2 coagulation analyzer with build-in micro-printer  
 C2000-1 coagulation analyzer  
 The pipetter with Automatic and electronic start



## Precil Coagulation Analyzer C2000-2 Double Channel Semi-Auto

### System configuration

C2000-4/2 coagulation analyzer with build-in micro-printer  
 C2000-1 coagulation analyzer  
 The pipetter with Automatic and electronic start

Test items: PT: Prothrombin Time, APTT: Activated Partial Thromboplastin Time

FIB: Fibrinogen ,TT: Thrombin Time , ProC: Protein C,ProS: Protein S

High Molecular Weight Haperin  
 Low Molecular Weight Haperin

Lupus Anticoagulant ,  
 Thrombin factor: (II III VIII IX X XI XII)estimation



# PIPETTES

Accuracy Counts

## Across Pro Pipettes

Analytical, Precision & Portable Balances



### Pipettes

Model	Volume Range	Volume µL	Increment µL	Accuracy %	Accuracy µL (±)	Precision %	Precision µL (±)	Item Number
AO-2	0.1 - 2µL	0.2	0.002	12	0.024	6	0.012	30079258
		1.0		2.7	1.3	0.013		
		2.0		1.5	0.7	0.014		
AO-10	0.5 - 10µL	1	0.02	2.5	0.025	1.2	0.012	30079259
		5		1.5	0.6	0.03		
		10		1	0.4	0.04		
AO-20	2 - 20µL	2	0.02	7.5	0.15	2	0.04	30079260
		5		3	0.9	0.045		
		10		1.5	0.5	0.05		
		20		1	0.3	0.06		
AO-100	10 - 100µL	10	0.2	3.5	0.35	1	0.1	30079261
		50		0.8	0.4	0.12		
		100		0.8	0.8	0.15		
AO-200	20 - 200µL	20	0.2	2.5	0.5	1	0.2	30079262
		100		0.8	0.8	0.25		
		200		0.8	1.6	0.15		
AO-1000	100 - 1000µL	100	2	3	3	0.6	0.6	30079263
		500		0.8	4	1		
		1000		0.8	8	1.5		
AO-5000	500 - 5000µL	500	2	2.4	12	0.6	3	30079264
		2500		0.6	15	0.2		
		5000		0.6	30	0.16		
AO-10mL	1 - 10mL	1mL	20	5	50	0.6	6	30079265
		5mL		50	0.2	10		
		10mL		60	0.16	16		

### Other Standard Features and Equipment

- Plastic tip ejector that won't rust
- Plunger button and tip color are coordinated to assist with easy identification of correct tips for the pipette



# PH METERS

Analytical, Precision



## Starter 3100 F



- Range: -2.00 - 16.00 pH
- Resolution: 0.01 pH
- Dimension: 220 W - 175 D - 78 H mm
- Three-point calibration for the highest accuracy
- Automatic and manual temperature compensation
- Automatic and manual endpoint functions determine the stability of readings
- The height of the standalone electrode holder can be adjusted for maximum versatility
- Auto buffer recognition helps to avoid errors during the calibration process
- 99 sets of data memory and the ability to instantly recall the last calibration data
- Self-diagnostic software provides assurance that the meter is in proper working condition
- Each time a pH sensor is calibrated, an icon appears on the display to confirm the accuracy of the calibration process so you can ensure accurate measurement
- Connection to peripheral devices through RS232 port
- The height of the electrode holder can be adjusted to optimize placement of the electrode

## Starter 3100 CF



- Among Starter 3100C's user-friendly features that support ease-of-use are an adjustable standalone electrode holder and large backlit LCD display.
- Documenting measurement data is made simple through the RS232 which can be used to connect peripheral devices such as printers or computers to the meter.
- Starter 3100C's intuitive software includes four calibration points, automatic and manual endpoint functions, and one touch conversion between measurement modes.



Balance accuracy from.... CROWN HEALTHCARE

# PH METERS & BALANCES

Analytical, Precision



## Starter 300PH

- Automatic and manual temperature compensation ensures accurate readings while a 30 measurement library stores data for future reference.
- The auto buffer recognition stores calibration data and helps to avoid errors during the calibration process.
- With a meter stand, wrist strap for secure field use and IP54 housing, Starter 300 is durable and prepared for versatile use.



## Starter ST10PH

- Simple Operation in a **Slim and Portable Design** – Starter pen meters provide what should be expected of a small pen meter: **simple, fast, straight forward**, no-frills yet highly accurate operation time and time again.
- Durably Constructed to **Withstand Wear and Tear** Resulting from Repetitive use – With durable plastic housing, a protective **cap that safeguards the sensor and an automatic shutdown** feature to preserve battery life, the Starter pen meters can endure consistent use in rugged environments.
- Waterproof Housing Protects the Meters in their Working Environment – Equipped with a wrist strap that helps to prevent unintentional dropping, Starter pen meters are constructed with an **IP67 waterproof design** that can prevent water damage when accidentally dropped into liquid.

# BALANCES

Portable Balances



## Emerald SCALE

- Unique hand-held design
- Quick and easy calibration
- g, dwt, and oz t jewelry units
- Energy-saving auto shut-off feature
- Large high contrast display
- Backlit display and protective cover
- New increased weighing capacities



## Adventurer

- Performance is ready for your lab-no matter where in the world you are.
- An intuitive color touchscreen is ready for your lab-even with gloves on.
- Connectivity options, such as a front USB port are ready for your lab.
- When workspace is at a premium, the space-saving draft shield is ready for your lab.



# BALANCES

## Portable Balances



### Navigato XL

- With less than a one second stabilization time, Navigato XL generates exceedingly accurate results quickly for applications requiring capacities up to 20kg.
- Operate the balance with the two touchless sensors that free up your hands for the handling of samples while limiting keypad wear and tear.
- The superior mechanical overload protection system safeguards the balance from sustaining damage when loads of up to 400% of its rated capacity are placed on the pan.



### Navigator NV

- Two touchless sensors free up your hands for handling samples and limiting keypad wear and tear.
- Ultra-fast stabilization in less than one second provides fast, accurate and repeatable weighing results, improving operator efficiency, productivity and throughput.
- Superior mechanical overload protection system & integrated shipping lock allows the scale to withstand loads up to 400% of its rated capacity, and protects the weighing cell from damage during transportation or storage.
- Liquid Crystal Display (LCD) with Backlight
- ABS plastic housing, 304 stainless steel pan



### Scout® Pro

- Application:** Weighing (7 units), parts counting (with auto optimisation), percentage weighing, totalisation, display hold
- Display:** LCD plus optional auxiliary display
- Operation:** Mains or battery (not incl.) with low battery indicator and programmable auto-off
- Communication:** Optional RS232 or USB interface with cable
- Construction:** ABS plastic with stainless steel pan
- Design Features:** Fixed integral weigh below hook, stability indicator, over and underload indicators, shipping lock, calibration lock, calibration weight supplied with 120 g, 200 g, 400 g, 600 g models



### Pioneer Precision

- Application:** Weighing (18 units + 1 custom unit), parts counting, percentage weighing
- Display:** LCD plus optional auxiliary display
- Operation:** Mains power
- Communication:** Rs232 for sending balance ID and weight - GLP (Time & Date) with optional SF40A Printer
- Construction:** Solid die cast metal base, stainless steel pan
- Design Features:** Fixed integral weigh below hook, all-glass draftshield with 3 sliding doors, front levelling bubble, menu and calibration locks



### Pioneer Precision

- Application:** Weighing (18 units + 1 custom unit), parts counting, percentage weighing
- Display:** LCD plus optional auxiliary display
- Operation:** Mains power
- Communication:** Rs232 for sending balance ID and weight - GLP (Time & Date) with optional SF40A Printer
- Construction:** Solid die-cast metal base, stainless steel pan
- Design Features:** Fixed integral weigh below hook, all-glass draftshield with 3 sliding doors on 1 mg models, front levelling bubble, menu and calibration locks



### Pioneer Analytical

- Analytical balance with 210g capacity and 0.1mg readability (also called accuracy)
- High-contrast, backlit LCD displays weight and application information
- Stainless steel 9cm diameter weighing pan is corrosion resistant
- Indicator on front panel ensures that the balance is level before each use
- Balance sensitivity can be adjusted to compensate for environmental conditions, and to ensure accurate results

# RAPID TESTS

## Accurate & Fast



### Rapid Test Abon USA Per Test

- Syphilis Rapid Test
- HBs Ag Whole Blood Serum/Plasma Strips
- H.Pylori Rapid Test
- Tuberculosis Rapid Test
- PSA Prostate specific Antigen Test
- Fecal Occult Blood Test
- Rota Virus Rapid Device
- Adeno Virus Rapid Device
- cTnI Troponin Whole Blood Test
- HCV Hepatitis C
- Self Stick Urine Analysis Strips
- Malaria Rapid Test



### Rapid Test

- H. pylori Rapid Test
- HBsAg Rapid Test
- H. pylori Antigen Test
- Syphilis Rapid Test
- Pregnancy Rapid Test
- Malaria Rapid Test
- S. Typhi Rapid Test

# RAPID/LATEX TESTS

Accurate & Fast



## Urine Analysis Strips

CODE	DESCRIPTION	UNITS
DL-SS001	Self Stick Urine Analysis Strips 1	100's
DL-SS002	Self Stick Urine Analysis Strips 2	100's
DL-SS003	Self Stick Urine Analysis Strips 3	100's
DL-SS010L	Self Stick Urine Analysis strips 10 L	100's
DL-SS011L	Self Stick Urine Analysis strips 11 L	100's
DL-UA120	Acon Urine Analyzer U120 Tests per Hour	

## Blood Grouping



CODE	DESCRIPTION
DN-BGA10-A	Blood Grouping A 10ml
DN-BGA10-B	Blood Grouping B 10ml
DN-BGA10-AB	Blood Grouping A/B 10ml
DN-BGA10-SERA	Blood Grouping D 10ml
DN-BA10	Bovine Albumin 30%
DN-AG10	Anti-Human Globulin 10ml
DN-BGA10-A	Blood Grouping A 10ml
DN-BGA10-B	Blood Grouping B 10ml
DN-BGA10-AB	Blood Grouping A/B 10ml
DN-BGA10-SERA	Blood Grouping D 10ml
DN-BA10	Bovine Albumin 30%
DN-AG10	Anti-Human Globulin 10ml

## LATEX TEST- Biosystems



CODE	DESCRIPTION	UNITS
Lab-bs31019	Anti-streptolysin O (aso) Screening	50 Tests
Lab-bs31013	Rheumatoid Factors (rf) Screening	50 Tests
Lab-bs33307	Salmonella Typhi H	5 MI
Lab-bs33308	Salmonella Typhi O	5 MI
Lab-bs33311	Proteus Ox19	5 MI
Lab-bs33312	Proteus Ox2	5 MI
Lab-bs33313	Proteus Oxk	5 MI
Lab-bs31011	C-reactive Protein (crp) Screening	50 Tests
Lab-bs36001	Rpr-carbon	100 Tests



# LABORATORY

Glassware And Accessories



Mortar & Pestel Glass



Mortar & Pestel Ceramic



Petri Dish Glass 90mm Chinese



Measuring Cylinder Glass



Measuring Cylinder Plastic



Pipette Serological



Centrifuge Tube 15ml Plastic



Dropper Bottles Amber



Test Tube



Separating Funnel 500 ml, Borosilicate



Volumetric Flask 2ltrs



Glass Funnel 50mm

# LABORATORY

## Glassware And Accessories



Beaker 5000 ml Glass



Round Bottom Flask



Flat Bottom Flask

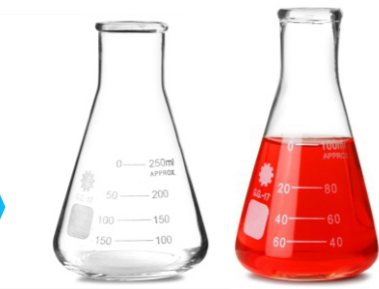

Conical Flask



Reagent Bottle Amber

Quality Glass & Plastic Units



Right equipment for every task



# CLINICAL CHEMISTRY

## Analyzers



### BTS-350 Semi-Automatic Analyzer LED Technology

#### Features:

- Complete Range of LEDs (340-405,505,535,560,600,635,670nm)
- Durable, humidity Proof Hard Coated Filters + 2 free positions
- Black BOX-Optics. Sealed Optic Systems-no Filter Wheel
- Battery Pack Power Failure (2 hrs)
- Monochromatic/Bichromatic Reading
- Spectral Range (340-670 nm)
- Photometric Rang (0.0 to 3.5A) for all Wave lengths
- Sipping volume from 100 µL- 5000 µL
- Temp System from 25° - 40°C (1° C increment) controlled by Peltier
- Sample Tubes includes common cuvettes (macro, semi-micro & micro) and round bottom
- Ergonomic designed accessible Pulse for sample loading
- Prog Memory Up to 150 Techniques
- Backlit Graphic Display 320 x 240 pixels with contrast settings
- Tactile Membrane Keyboard
- USB and serial RS-232 for external Computer Use
- Thermal Printer (easy loading)
- Patient Result up to 2000 with blank and calibration values can be stored
- Levy-Jennings QC chart based on (Westgard's rule)
- Calibration by Factor, single calibrator or calibration curve
- Kinetics by Linear Regression
- PC Communication Software
- Weight 4 kgs
- Flow Cuvette 18 µL



### A15 Random Access Analyzer

- Clinical Chemistry dedicated reagents
- **Throughput of 150 test/hour**
- 4 independent positions for samples and reagent racks
- 24 samples for rack (maximum capacity of 72 samples in racks)
- 10 reagents for rack (maximum capacity of 30 reagent bottles in racks)
- **20 and 50 mL reagent bottles**
- Primary tubes or paediatric cups as sample containers
- Unlimited STAT capabilities. Run at any time
- Programming of 5 kinds of samples (serum, plasma, urine, CSF & whole blood)
- Up to 15 minutes reading time
- Reusable methacrylate rotor
- Minimum reading volume of 200 µL
- Measurement Range from -0.05 A to 2.5 A
- Spectral range 340 nm to 900 nm
- Filter configuration 340, 405, 505, 535, 560, 600, 635, 670 nm.

Quality that Lasts

# CLINICAL CHEMISTRY Analyzers

## A25 Random Access Analyzer



- Throughput of 240 tests/hour
- Clinical Chemistry and Turbidimetry dedicated reagents
- 30 refrigerated positions by 20 and 50 mL reagents bottles
- Flexibility in positioning with sample and reagents racks
- Unlimited STAT capabilities. Run at any time
- Minimum reading volume of 200 ul
- Filter configuration 340,405,505,535,560,600,635,670 nm
- Automatic conditioning of fluid system

## BS-200 Clinical Chemistry Analyzer

A bench-top, discrete and random access clinical chemistry analyzer offering 200 tests per hour

- Features:**
- 200 tests per hour, up to 330 tests per hour with ISE (K, Na, Cl)
  - 24-hour refrigeration for reagent tray
  - Built-in bar code scanner
  - Independent mixing stirrer
  - Robust and user-friendly operation software
  - Multi-language version available
  - Pre-dilution and post-dilution for sample
  - Bi-directional LIS interface



## BS-200E Chemistry Analyzer

A floor-standing, discrete and random access clinical chemistry analyzer offering constant 200 tests per hour.

- Discrete, random access, fully automated, bench-top
- Constant 200 tests per hour, up to 330 tests per hour with ISE
- Auto washing system with pre-warmed detergent and water
- Grating optical system
- 150µl minimum reaction volume
- Independent mixing bar
- Reusable reaction cuvettes
- Bi-directional connection to LIS host



## BS-230 Fully Clinical Chemistry Analyzer

BS-230 is a "CUTE", multi-functional benchtop clinical chemistry analyzer with a throughput at 200 T/H, up to 400 T/H with ISE. Though with a compact size, it has achieved a host of advanced functions never before found on a like product in the market, making it an optimal chemistry solution for small laboratories and a back-up tool for mid-to-high end laboratories.

- Features:**
- Discrete, random access, fully automated, bench-top
  - Up to 200 tests per hour, or 400 tests per hour with ISE
  - Flexible Loading, Large capacity of 80 reagent positions and 40 sample positions extendable to 80
  - 100µl minimum reaction volume
  - Disposable Cuvettes to avoid contamination
  - Probe carryover less than 0.05%



## BS-240 Fully Clinical Chemistry Analyzer

Though with a compact size, it has achieved a host of advanced functions never before found on a like product in the market, making it an optimal chemistry solution for small laboratories and a back-up tool for mid-to-high end laboratories.

- Discrete, random access, fully automated
- 200 tests per hour, up to 400 tests per hour with ISE
- 80 Reagent and 40 Sample Position
- Minimal reagent volume 100ul
- Refrigerated reagent & sample compartment
- Automatic probe cleaning, liquid level detection & collision protection
- Whole blood testing function for HbA1c
- Automatic dilution for abnormal sample
- 8-step auto wash system 80 semi-permanent cuvettes
- High efficiency stand along mixing bar
- Inbuilt barcode reader
- Bi-directional LIS interface



## BS-380 Clinical Chemistry Analyzer

A floor-standing, discrete and random access clinical chemistry analyzer offering a constant 300 tests per hour

- Features:**
- Medium-sized laboratories (used as a main instrument); large laboratories (used as a back-up)
  - Constant 300 tests per hour, up to 450 tests per hour with ISE (K, Na, Cl)
  - 24-hour refrigeration for reagent tray
  - Reusable cuvettes with auto-washing station
  - Independent mixing stirrer (two-in-one)
  - Automatic probe cleaning, liquid level detection & crash protection (vertical & horizontal)
  - Reversed grating system with 12 wavelengths
  - Built-in bar code scanner
  - Pre-dilution and post-dilution for sample
  - Bi-directional LIS interface



## BS-400 Clinical Chemistry Analyzer

A floor-standing, discrete and random access clinical chemistry analyzer offering a constant 400 tests per hour

- Features:**
- Constant 400 tests per hour, up to 640 tests per hour with ISE (K, Na, Cl, Li)
  - 24-hour refrigeration for reagent tray
  - Reusable cuvettes with auto-washing station
  - Two independent mixing stirrers
  - Clot detection and crash protection (vertical & horizontal)
  - Reversed grating system with 12 wavelengths
  - Built-in bar code scanner
  - Pre-dilution and post-dilution for sample
  - Bi-directional LIS interface

# CLINICAL CHEMISTRY



## Equipments



### BS-480 Chemistry Analyzer

This is a versatile mid to high volume chemistry platform with conventional software design, easy to navigate interface; creating a positive user experience in today's fast-paced laboratory environment. The wide selection test menu includes general chemistries, electrolytes and drug abuse testing serving the need of most clinical laboratories and hospitals.

#### Features & Benefits

- Constant 400 T/H, up to 560 T/H with ISE
- 80 reagent positions; 90 sample positions
- 90 permanent glass cuvettes
- 8 step auto washing
- Grating optical system: 340nm to 800nm
- R1, R2, R3, R4 reagent combo
- Probe level sense, collision, bubble and clot detection
- Auto-rerun, auto-serum index, auto-dilution
- Auto-reflexive testing
- 5 minutes daily maintenance
- Simultaneous multi-lots reagent calibration



### BA-88A Semi-Auto Clinical Chemistry Analyzer

A semi-automatic chemistry analyzer with large touch-screen and easy-to-use operation software

#### Features:

- 7.0" TFT touch-screen & pop-up keypad
- Two test mode: flowcell or cuvette
- Supports bi-chromatic tests for end point, fixed-time, kinetics methods
- External keyboard or mouse support via USB
- User-friendly interface and multi-language operation software
- Built-in thermal printer
- Weight 6.8 Kgs



### SEMI-AUTOMATIC ANALYZER BTS-350

- Complete Range of LEDs (340, 405, 505, 535, 560, 600, 635, 670 nm) + 3 free positions for optional filter
- Durable, humidity Proof Hard Coated Filters
- Black BOX-Optics Sealed Optic Systems-no Filter Wheel
- Battery Pack Power Failure (2 hrs)
- Monochromatic/Bichromatic Reading
- Photometric Rang (0.0 to 3.5A) for all Wavelengths
- Sipping volume from 100 µL- 5000 µL
- Flow Cuvette 18 µL
- Ergonomic designed accessible Pulse for sample loading
- Prog Memory up to 150 Techniques
- Tactile Membrane Keyboard
- USB and serial RS-232 for external Computer Use
- Thermal Printer (easy loading)
- Levy-Jennings QC chart based on Westgard's rule
- Calibration by Factor, single calibrator or calibration curve
- Kinetics by Linear Regression
- PC Communication Software
- Power only 30 W

# ELECTROLYTE & BLOOD GAS ANALYZERS



### EasyLyte Analyzer

EasyLyte is a completely automated, microprocessor-controlled analyzer that uses advanced ISE (Ion Selective Electrode) technology to make electrolyte measurements.



### Medica EasyBloodGas analyzer

Medica's EasyBloodGas™ offers traditional blood gas analysis in a new compact format. The small footprint saves space and integrates easily into laboratory workflows.

### Eden EasyBloodGas analyzer i15



- 24 hours standby without consumption
- Maintenance free
- Fast, accurate, and convenient build-in automatic alibration
- Automatic sample aspiration and constant temperature measurement assure accuracy and reliability.
- Results in 1 minute after sample aspiration
- Wired or wireless networking capability.
- Seamless integration with LIS/HIS
- USB ports for data transfer
- 10,000 patient data storage



Quality Analyzer Solution



# HEMATOLOGY ANALYZERS



## 3-Part WBC Differentials



### BC-20s Auto Hematology Analyzer [Touch Screen]

BC-20s. Complete with an intuitive operation system, convenient data communication interface, excellent performance, BC-3600 is a system solution for satellite labs and clinics.

**Features:**

- CBC+3-DIFF, 19 parameters+3 histograms
- Throughput: 40 samples per hour
- Intuitive operation system with 8.4 inch TFT touch screen
- Open vial sampling
- 200,000 results storage with histograms
- Original QC, calibrators and reagents



### BC-30s Auto Hematology Analyzer

Minimum Size, Maximum Capability

**Features:**

- CBC+3-DIFF, 21 parameters+3 histograms
- Throughput: 70 samples per hour
- Intuitive operation system with 10.4 inch TFT touch screen
- Open vial sampling
- 500,000 results storage with histograms
- Original QC, calibrators and reagents

## 5-Part WBC Differentials

### BC-5300 Auto Hematology Analyzer



The new BC-5300 Auto Hematology Analyzer is a bench-top system, combining state-of-the-art technologies to provide reliable and accurate five-part hematology results from just 20uL of blood. The Windows-based software also provides many advanced features to enhance lab efficiency. BC-5300 requires zero daily maintenance and is equipped with an automatic cleaning set-up to make daily use as easy as possible.

- 5-part differentiation, 27 parameters, 1 scattergram and 3 histograms
- Semi-conductor Laser Scatter combined with Chemical Dye method and Advanced Flow Cytometry.
- Only 20ul sampling volume
- 60 samples per hour
- 2 counting modes: Whole blood and Prediluted
- Large storage capacity: up to 40,000 samples
- PC software and Bi-directional LIS connection



### BC-5380 Auto Hematology Analyzer

Affordable automation for small labs

- Auto Hematology Analyzer
- 5-part differentiation, 27 parameters, 1 scattergram and 3 histograms
- Semi-conductor Laser Scatter combined with Chemical Dye method and Advanced Flow Cytometry.
- Only 20ul sampling volume
- Up to 60 samples per hour
- 2 sampling modes: Autoloader and Closed Tube
- Large storage capacity: up to 40,000 samples
- PC software and Bi-directional LIS connection



### BC-5800 Auto Hematology Analyzer

One-stop hematology workstation

- 5 part differentiation, 29 parameters, 2 histograms+2 scattergrams
- Laser scatter technology combined with chemical dye method and Flow cytometry
- 2 counting modes: Whole blood and Prediluted
- Up to 90 samples per hour
- Optional auto loader, bar code scanner
- Large storage capacity: up to 40,000 samples
- Bi-directional LIS connection
- Customizable Re-exam rules

### BC-6800 Auto Hematology Analyzer



- 40 reportable parameters, 19 research parameters, 4 scattergrams (3D), 7 scattergrams (2D), 3 histograms;
- SF Cube Cell Analysis Technology (flow cytometry combined with laser scatter and fluorescence) and Focusing Flow-DC method;
- Autoloader capacity of 100 sample tubes with random & continuous loading;
- Throughput up to 125 samples per hour (CBC+DIFF);
- Maximum sample consumption of 200 µl in autoloader mode;
- Body fluid analysis in manual mode (cerebrospinal fluid and serous fluids -peritoneal and pleural);
- Data storage capacity of 100,000 patient results including all numeric and graphical information;
- Ability to flag abnormal cells based on customizable decision rules;
- Re-exam rules to pull out abnormal samples for further checking;
- Supports bi-directional LIS connection with communication protocols HL7 or ASTM;
- No daily maintenance.



# IMMUNOASSAY

Antigens & Antibodies



## Microplate Reader MR 96 Mindray Elisa Microplate Reader

- Touch-screen, 7.8" large color LCD display
- Opaque lid to prevent stray light
- Built-in thermal recorder, optional external printer
- Non-volatile memory stores up to 20,000 results
- Multiple Curve-fitting options
- Variable time and speed shaking modes
- Fully automatic bi-chromatic optical system
- Extensive report with patient information
- Long life lamp with lamp saver feature
- Powerful data management software (optional)



## Mindray Elisa Microplate Washer

- Two rinsing bottles avoids bottle change
- Compatible with flat, U- or V-bottom plates
- 2 wash modes with interchangeable manifolds for 8- and 12-well strips
- Automatic bottom detection and collision protection
- Variable shaking and soaking time

Semi Automated

# ORTHO CLINICAL

DIAGNOSIS

VITROS

## VITROS®250/350 Dry Chemistry Systems



Providing fast, accurate results is a necessity—even for small labs—with growing pressure to reduce errors and cut costs in the midst of increased demands and significant staffing shortages.

The VITROS® 350 System is a compact chemistry system designed to be efficient, dependable, and, above all, easy to use as a primary, STAT, or backup system

## VITROS®4600/5.1 FS Chemistry System



Every day, labs like yours face the challenge of improving patient care while balancing staffing, compliance, and total operating cost containment.

With proven technologies and a comprehensive chemistry menu for both routine and specialty testing, the VITROS® 4600 System is designed to help you confidently and efficiently deliver chemistry results to the physicians and patients who depend on you.



## CL - 1000i Chemiluminescence Immunoassay System



A fully capable and robust immunoassay analyzer with performance consistent with CL-2000i, in a smaller benchtop package better suited for mid-to-small-sized labs. With throughput of 120 tests per hour, this system features its large reagent and sample capacity, reliable performance and user-friendly operation interface.

- Up to 120 tests per hour
- 25 reagent positions
- User-friendly operation interface
- Continuous sample loading and off-loading
- Touch screen monitor with a swing arm (optional)

## CL - 2000i Chemiluminescence Immunoassay System



- High test throughput up to 240 T/H
- Large capacity for sample and reagent processing
- User-friendly software interface
- Flexible connection with BS-800M/BS-2000M chemistry system

Fully - Automated Analyser

# ORTHO CLINICAL DIAGNOSIS

# VITROS

## VITROS® EciQ / Eci Immunoassay System



Whether it's routine or specialty immunodiagnostic testing, accurate results are critical for the doctors and patients whose treatment decisions depend on them. The VITROS® EciQ Immunodiagnostic System is a versatile system that verifies and documents each step throughout processing. This means you can count on the result integrity and quality you need to confidently deliver the results that matter.

## VITROS® 3600 Immunodiagnostic System



**Today's laboratories require accurate, precise, fast, and nonstop testing. Designing an immunoassay system to deliver on these needs takes a level of understanding that only comes from first-hand experience.** Based on the study, input, and feedback of a diverse group of laboratories from around the world, the VITROS® 3600 System is built to handle peak testing workloads and maximize turnaround and system walkaway times.

## VITROS® 5600 Integrated System



**Laboratories are constantly under pressure to produce faster, higher quality results, even under increased demands.**

The VITROS 5600 is an integrated system that brings together 5 proven technologies designed to remove the obstacles to reducing turnaround time and increasing your ability to provide meaningful

## ORTHO® AutoVue Innova System



**No matter how quickly you need to produce results or how much pressure you have to control costs, you know that no margin of error is acceptable in a blood bank.** We designed the ORTHO AutoVue® Innova System to comprehensively address safety—from helping to reduce the potential for human increased automation and ease of use to increasing accuracy with dozens of additional process checks. So you can be ready to meet your toughest challenges with full confidence in the safety of your results.

## ORTHO VISION™ Analyzer

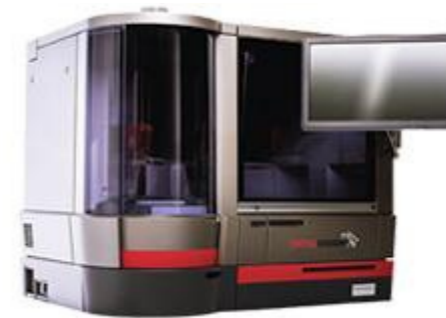

**A blood banker's job is critical, yet labs face growing pressure to find new efficiencies and do more with less.** The ORTHO VISION™ Analyzer was developed to meet the unique needs of immunohematology labs through the proprietary benefits of **Responsive Automation**. This analyzer not only raises the bar in transfusion medicine—it redefines it.

## ORTHO™ VIP



**In order for blood to travel safely from donor to patient, great care must be taken at each step in the process—from the collection of blood to the transfusion of the patient.** And today's financially strained environment calls for enhanced cost-efficient automation of that process to deliver a reduced labor-intensive solution within a process-controlled environment. The answer is the ORTHO VERSEIA® Integrated Processor (VIP)—an automated pipetting and processing system that brings together the ORTHO VERSEIA® Pipetter and ORTHO® Summit Processor to enable end-to-end pipetting and processing.

## ORTHO™ Workstation



Precision and accuracy are critical in labs of any size. The ORTHO™ Workstation is the only compact 2-in-1 blood testing system with reliable ID-Micro Typing System™ (ID-MTS™) Gel Column Agglutination Technology (CAT). It's a system engineered to help ensure the accuracy your patients deserve—with the convenience and ease of use your lab needs.



**enGen**

## enGen™ Automation

enGen™ Automation is designed to work with your all of your VITROS® Systems—VITROS® 5600 Integrated System, VITROS® 4600 Chemistry System, VITROS® 3600 Immunodiagnostic System, VITROS® 5,1 FS Chemistry System, VITROS® EciQ Immunodiagnostic System (off-track), and VITROS® 250/350 Chemistry System (off-track).



# CLINICAL CHEMISTRY



	Code	Description	Unit	Trade Price	Brand	Tests
<b>Liver Function</b>	11533	ALANINE AMINOTRANSFERASE (ALT/GPT)	1 x 200ml	4,500.00	BioSystems	200
	11531	Aspartate Aminotransferase (AST/GOT)	1 x 200ml	4,500.00	BioSystems	200
	11573	Albumin	1 x 250ml	1,400.00	BioSystems	250
	11510	Bilirubin Total	4 x 50ml	4,000.00	BioSystems	200
	11511	Bilirubin Direct	4 x 50ml	4,000.00	BioSystems	200
	11515	Bilirubin Total and Direct	2 + 2 * 50ml	3,200.00	BioSystems	200
	11513	Bilirubin Standard	1 x 5ml	600.00	BioSystems	5
	11588	Cholinesterase (CHE)	1 x 50ml	5,200.00	BioSystems	50
	11589	Cholinesterase (CHE)	4 x 50ml	14,000.00	BioSystems	50
	11591	Alkaline Phosphate Dea	1 x 250ml	3,200.00	BioSystems	250
	11584	Gamma-GlutamylTRANSFERASE (G-gt)	1 x 50ml	2,600.00	BioSystems	50
	11520	Gamma-GlutamylTRANSFERASE (G-gt)	1 x 200ml	8,000.00	BioSystems	200
	11572	Protein (Total)	1 x 250ml	1,400.00	BioSystems	250
	11500	Protein (Total)	2 x 250ml	2,000.00	BioSystems	500
<b>Lipid Protein</b>	11505	Cholestrol	1 x 200 ml	4,000.00	BioSystems	200
	11506	Cholestrol	1 x 500 ml	8,000.00	BioSystems	500
	11648	Cholestrol HDL Precipitating Reagent	1x 50 ml	1,200.00	BioSystems	50
	11579	Cholestrol LDL Precipitating Reagent	1 x 20 ml	2,000.00	BioSystems	20
	11557	Cholesterol HDL Direct	1 x 80ml	12,000.00	BioSystems	80
	11585	Cholesterol LDL Direct	1x 80 ml	18,000.00	BioSystems	80
	11828	Triglycerides	1 x 50ml	2,000.00	BioSystems	50
	11528	Triglycerides	4 x 50ml	7,000.00	BioSystems	200
<b>Renal</b>	11521	Uric Acid	1 x 200ml	5,000.00	BioSystems	200
	11522	Uric Acid	1 x 500 ml	9,000.00	BioSystems	500
	11502	Creatinine	4 x 50ml	3,800.00	BioSystems	200
	11536	Urea/Bun-Color	4 x 50ml	3,000.00	BioSystems	200
	11537	Urea/Bun-Color	2 x 250ml	6,000.00	BioSystems	500
<b>Iron</b>	11581	Lactate Dehydrogenase (LDH)	1 x 200ml	5,000.00	BioSystems	200
	11743	Hemoglobin	1 x 20ml	2,200.00	BioSystems	20
	11744	Hemoglobin Standard	1 x 1ml	2,000.00	BioSystems	1
<b>Diabetes</b>	11503	Glucose	1 x 200ml	1,800.00	BioSystems	200
	11504	Glucose	1 x 500 ml	3,800.00	BioSystems	500
	11046	Fructosamine	2 x 50ml	10,800.00	BioSystems	100
<b>Electrolute</b>	11527	Calcium-MTB	4 x 50ml	1,800.00	BioSystems	200
<b>Cardiac</b>	11583	a - Amalays Direct	5 x 5ml	4,000.00	BioSystems	25
	11549	Lipase	4 x 15ml		BioSystems	60
<b>Controls</b>	18009	Biochemistry Control Serum Level 1	5 x 5 ml	5,200.00	BioSystems	25
	18010	Biochemistry Control Serum Level 2	5 x 5 ml	5,200.00	BioSystems	25

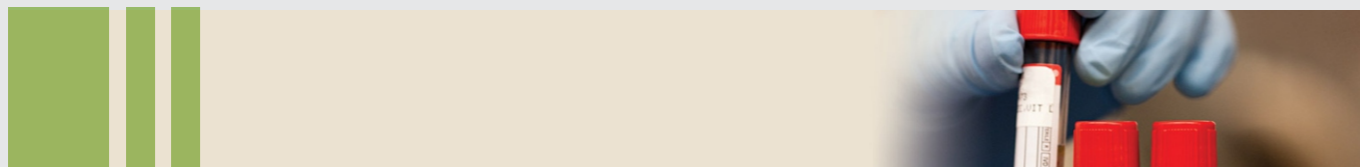

# CLINICAL CHEMISTRY & TURBIDIMETRY AUTOMATED KITS

## Liver Function

Code	Descripton	Pack Size	Total Mls	Tests
12533	Alanine Aminotransferase (ALT/GPT)	5 x 50 mL	250	784
12531	Aspartate Aminotransferase (AST/GOT)	5 x 50 mL	250	784
12511	Bilirubin (Direct)	5 x 50 mL	250	784
12510	Bilirubin (Total)	5 x 50 mL	250	784
12500	Protein (Total)	10 x 50 mL	500	1,567
12518	Alkaline Phosphatase (ALP-AMP)	5 x 20 mL	100	313
12514	Alkaline Phosphatase (ALP-DEA)	5 x 20 mL	100	313
12547	Albumin	5 x 50 mL	250	784
12520	Gamma Glutamylase (g-GT)	5 x 50 mL	250	784

## Lipids

Code	Descripton	Pack Size	Total Mls	Tests
12505	Cholesterol	10 x 50mL	500	1,567
12557	Cholesterol HDL Direct	4 x 20mL	80	251
12585	Cholesterol LDL Direct	4 x 20mL	80	251
12528	Triglycerides	10 x 50 mL	500	1,567

## Renal

Code	Descripton	Pack Size	Total Mls	Tests
12502	Creatinine	10 x 50 mL	500	1,567
12516	Urea/Bun- UV	5 x 50 mL	250	784
12501	Protein (Urine)	5 x 50 mL	250	784
12521	Uric Acid	10 x 50 mL	500	1,567

## Electrolytes

Code	Descripton	Pack Size	Total Mls	Tests
12570	Calcium-Arsenazo	10 x 50mL	500	1,567
12512	Magnesium	2 x 50 mL	100	313
12508	Phosphorous	2 x 50 mL	100	313

## Iron

Code	Descripton	Pack Size	Total Mls	Tests
12509	Iron-Ferozine	5 x 50 mL	250	784

## Diabetes

Code	Descripton	Pack Size	Total Mls	Tests
12503	Glucose	10 x 50 mL	500	1,567

# CLINICAL CHEMISTRY & TURBIDIMETRY AUTOMATED KITS



## Cardiac

Code	Descripton	Pack Size	Total Mls	Tests
12580	Lactate Dehydrogenase (LDH)	5 x 50 mL	250	784
12550	Amylase Direct	5 x 20 mL	100	313

## Turbidimetry

## Diabetes

Code	Descripton	Pack Size	Total Mls	Tests
13324	Albumin (Microalbuminuria)	1 x 20 mL	20	47
13044	Hemoglobin A1C-Turbi	1x 50 mL	50	129

## Immunology

Code	Descripton	Pack Size	Total Mls	Tests
13084	Complement Component C3	1 x 20 mL	20	65
13085	Complement Component C4	1 x 20 mL	20	65
13082	Immunoglobulin A	1 x 20 mL	20	89
13081	Immunoglobulin G	1 x 20 mL	20	65
13083	Immunoglobulin M	1 x 20 mL	20	65

## Iron

Code	Descripton	Pack Size	Total Mls	Tests
13326	Ferritin	1 x 20 mL	20	180
13091	TRANSFERRIN	1 x 20 mL	20	44

## Rheumatoids

Code	Descripton	Pack Size	Total Mls	Tests
13923	Anti-Streptolysin O (ASO)	2 x 20 mL	40	44
13921	C-Reactive Protein (CRP)	2 x 20 mL	40	65
13927	C-Reactive Protein-High Sensitivity (CRP-hs)	1 x 20 mL	20	161
13922	Rheumatoid Factors (RF)	1 x 50 mL	50	44

High Quality  
test Kits

## Stereo Zoom Scopes

Code	Descripton	Pack Size
18009	Biochemistry Control Serum Level 1	5 x 5 ml
18010	Biochemistry Control Serum Level 2	5 x 5 ml
18040	Lipid Control Serum Level 1	1mL
31211	Protein Control Level 1	1mL
31212	Protein Control Level 2	1mL
18011	Biochemistry Calibrators	5 x 5 mL
31075	Lipid Calibrator	1mL
31075	Protein Callibrators	1mL

## Accessories

Code	Descripton	Pack Size
AC11485	Reactions Rotor for A15	pcs
BO13416	Concentrated Washing Solution	100ml
BO11524	Concentrated Systems Liquid	1L
AC-10770	Sample Wells	1000units

# LABORATORY CHEMICALS

Code	Descripton	Code	Descripton
LR-8010	Acetone AR/ ACS 99.5%	LR-8400	Chloroform Ar 99.8% 2.50Lts
LR-8040	Aluminium Ammonium Sulphate (Dodecahydrate) Ar 99 500g	LR-8410	Citric Acid Ar (Monohydrate) 99.5% 500gm
LR-8030	Aluminium Ammonium Sulphate (Dodecahydrate) Extra 500g	LR-8420	Copper Oxide Wire Ar 100gm
LR-8050	Aluminium Sulphate Ar (18 - Hydrate) 99%	LR-8430	Cresol Red Indicator Ar 25gm
LR-8060	Ammonia Solution AR 25% 2.5L	LR-8440	Crystal Violet Ar C.I.No.42555 25gm
LR-8070	Ammonium Acetate AR 98% 500g	LR-8450	Crystal Violet Staining Solution 500ml
LR-8130	Ammonium Oxalate AR 99.5% 500g	LR-8460	Cupric Acetate (Monohydrate) 98% 250gm
LR-8260	Bromocresol Purple Indicator Ar 25gm	LR-8470	Cupric Carbonate (Basic) Extra Pure 95% 500gm
LR-8270	Bromophenol Blue Indicator Solution (0.04%Soln.) 125ml	LR-8480	Cupric Chloride (Dihydrate) 98% 500gm
LR-8280	Bromophenol Blue Indicator Solution (0.04%Soln.) 500ml	LR-8490	Cupric Nitrate Ar (Trihydrate) 99.5% 500gm
LR-8290	Bromothymol Blue Indicator Ar 5gm	LR-8500	Cupric Sulphate Anhydrous 98% 500gm
LR-8300	Bromothymol Blue Indicator Solution (0.04%Soln.) 500ml	LR-8510	Cupric Sulphate Ar (Pentahydrate) 99% 500gm
LR-8310	Buffer Tablets Ph 4.0 10tab	LR-8520	Cupric Sulphate Extra Pure (Pentahydrate) 500gm
LR-8320	Buffer Tablets Ph 7.0 10tab	LR-8530	D.P.X.Mountant 500ml
LR-8330	Buffer Tablets Ph 9.2 10tab	LR-8540	Dextrose (Monohydrate ) Ar 500gm
LR-8340	Calcium Nitrate Extra Pure (Tetrahydrate) 98% 500gm	LR-8550	Diethylether Ar (Stabilished) 99% 2.50Lts
LR-8350	Calcium Oxide (Lumps) Extra Pure 90% 500gm	LR-8580	Eriochrome Black T C.I.No.14645 25gm
LR-8360	Calcium Sulphate (Dihydrate) 500gm	LR-8590	Ethyl Acetate Ar 99% 2.50Lts
LR-8370	Calcon C.I.No.15705 25gm	LR-8600	Ethylene Diamine Tetra Acetic Acid Disodium Salt 500gm
LR-8380	Carbol Fuchsin Strong 500ml	LR-8610	Ethylene Diamine Tetra Acetic Acid Disodium salt Ar100gm
LR-8390	Charcoal Activated Ar (Phosphous Free) For Soil 100gm	LR-8620	Fehling'S Solution No.1 1.00Lts

# LABORATORY CHEMICALS

Code	Descripton	Code	Descripton
LR-8630	Fehling'S Solution No.2 1.00Lts	LR 9330	Methyl Orange Indicator Solution 500ml
LR-8640	Ferric Chloride (Hexahydrate) Ar 99% 500gm	LR-9340	Methyl Red (Ph Indicator Sol) 0.01% 500ml
LR-8650	Ferric Nitrate Extra Pure (Nonahydrate) 98% 500gm	LR-9350	Methyl Red Indicator Gr C.I.No.13020 25gm
LR-8660	Ferric Oxide Red 98.5% 500gm	LR-9360	Methyl Violet For Microscopy C.No.42535 25gm
LR-8670	Ferric Sulphate Extra Pure (Monohydrate) 500gm	LR-9370	Methylene Blue C.I.No.52015 25gm
LR-8680	Ferrous Sulphate Extra Pure (Heptahydrate) 500gm	LR-9380	Methylene Blue Solution 0.5% For Mroscopy 500ml
LR-8700	Field Stain A - Liquid 500ml	LR-9390	Millon'S Reagent 125ml
LR-8690	Field Stain A 25gm	LR-9400	Molybdic Acid 85% Ar 500gm
LR-8720	Field Stain B - Liquid 500ml	LR-9410	Neutral Red Indicator Gr C.I.No.50040 25gm
LR-8710	Field Stain B 25gm	LR-9420	Neutral Red Indicator Solution 500ml
LR-8730	Formaldehyde Solution 37-41% W/V, 5.00Lts	LR-9430	Nickel Carbonate 100gm
LR-8740	Formic Acid Ar 98% 500ml	R-9440	Nickel Chloride Extra Pure (Hexahydrate) 97% 500gm
LR-8750	Giemsa'S Stain 25gm	LR-9450	Nickel Sulphate Extra Pure (Hexahydrate) 98% 500gm
LR-8760	Giemsa'S Staining Solution 500ml	LR-9460	Nitric Acid Ar 69-71% 2.50Lts
LR-8770	Glycerol Ar 99% (Confirming To Bp Specification) 2.50Lts	LR-9470	Orange G 25gm
LR-8780	Glycerol Purified 98% 2.50Lts	LR-9480	Orthophosphoric Acid Ar 2.50Lts
LR-8790	Gram'S Iodine Staining Solutin 2.5Lts	LR-9490	Oxalic Acid Ar 99.5% 500gm
LR-8800	Hematoxylin (Harris) 500ml	LR-9500	Papanicolaous Solution 3B Polychromatic Solution 125ml
LR-8810	Hexane Ar 85% 2.50Lts	LR-9510	Paraffin Wax Pellets With Ceresin Congraling Point500gm
LR-8820	Hydrochloric Acid Ar 2.50Lts	LR-9520	Petroleum Ether 40-60 C Extra Pure 500ml
LR-8830	Hydrofluoric Acid 40% Ar 500ml	LR-9530	Petroleum Ether 60-80 C Ar 2.50Lts
LR-8840	Immersion Oil 125ml	LR-9540	Petroleum Ether 80-100C 500ml
LR-8850	Iodine (Resublimed) Ar 99.5% 100gm	LR-9550	Petroleum Ether Ar 40-60 C Ar 2.50Lts
LR-8860	Iodine (Resublimed) Extra Pure 98.5% 100gm	LR-9560	Phenol Detached Crystals Acs 99% 500gm
LR-8870	Iron (Metal) Powder Electrolytic 99.5% (250-300 Me)500gm	LR-9570	Phenol Red Ar 25gm
LR-8880	Iron (Metal) Filings (100 Mesh) 500gm	LR-9580	Phenol Red Indicator Solution (0.02%) 500ml
LR-8890	Iso-Amyl Acetate 98% 500ml	LR-9590	Phenolphthalein (Indicator) 25gm
LR-8900	Iso-Propyl Alcohol 99.8% For Hplc & For Spectrosc2.50Lts	LR-9600	Phenolphthaeoin (Indicator) Solution (1%) 500ml
LR-8910	Iso-Propyl Alcohol Ar 99.5% Confirming To Ip/Bp Sp2.50Lts	LR-9610	Phthalic Anhydride 98% 500gm
LR-8920	Karl Fischer Reagent Pyridine Free Single Solution500ml	LR-9620	Potassium Acetate Extra Pure 99% 500gm
LR-8930	Lactophenol (Cotton Blue) 500ml	LR-9630	Potassium Bromide Ar 99.5% 500gm
LR-8940	Lead (Ii) Chloride (Anhydrous) 99% 250gm	LR-9640	Potassium Bromide Extra Pure 99% 500gm
LR-8950	Lead Acetate Ar (Trihydrate) 99.5% 500gm	LR-9650	Potassium Carbonate Ar (Anhydrous) Ar 99.9% 500gm
LR-8960	Lead Carbonate Extra Pure 98% 500gm	LR-9660	Potassium Chromate Ar 99.5% 250gm
LR-8970	Lead Nitrate Ar 500gm	LR-9670	Potassium Chromate Purified 99% 500gm
LR-8980	Lead Powder (Lab) 99.5% 500gm	LR-9680	Potassium Dichromate Ar 99.9% 500gm
LR-8990	Leishman'S Stain For Microscopy 25gm	LR-9690	Potassium Dichromate Extra Pure 500gm
LR-9000	Leishman'S Stain Solution 500ml	LR-9700	Potassium Dihydrogen Orthophosphate (Anhydrous) 500gm
LR-9010	Light Green For Microscopy C.I.No.42095 25gm	LR-9710	Potassium Dihydrogen Orthophosphate Ar 500gm
LR-9020	Litmus (Ph Indicator) Solution (Red) 125ml	LR-9720	Potassium Ferricyanide 98% 500gm
LR-9030	Litmus (Ph Indicator) Solution (Red) 500ml	LR-9730	Potassium Ferrocyanide 98% 500gm
LR-9040	Litmus Blue Indicator Paper 200.00LVS	LR-9740	Potassium Ferrocyanide Ar 99% 500gm
LR-9050	Litmus Indicator Extra Pure 25gm	LR-9750	Potassium Hydrogen Phthalate Ar 500gm
LR-9060	Litmus Red Indicator Paper 200.00LVS	LR-9760	Potassium Hydrogen Sulfate Extra Pure 99% 500gm
LR-9070	Lysol (Cresol & Soap Solution) 5.00Lts	LR-9770	Potassium Hydroxide Pellets Ar Confirming To Bp/U500gm
LR-9080	Magnesium (Metal) Powder 99% Extra Pure 100gm	LR-9780	Potassium Iodate 99% 100gm
LR-9090	Magnesium (Metal) Ribbon 99.5% 25gm	LR-9790	Potassium Iodate Ar 99.5% 100gm
LR-9100	Magnesium (Metal) Turning 99.9% 500gm	LR-9800	Potassium Iodide 99.5% Confirming To Ip Specn. 100gm
LR-9110	Magnesium Acetate (Tetrahydrate) 98% Extra Pure 500gm	LR-9810	Potassium Iodide Ar 99.8% 250gm
LR-9120	Magnesium Carbonate (Light) Extra Pure 100gm	LR-9820	Potassium Metabisulphite 95% Extra Pure 500gm
LR-9130	Magnesium Chloride Ar (Hexahydrate) 98% 500gm	LR-9830	Potassium Nitrate Ar 99% Confirming To Bp/Usp Spec500gm
LR-9140	Magnesium Chloride Extra Pure98% (Hexahydrate) 500gm	LR-9840	Potassium Nitrate Purified 500gm
LR-9150	Magnesium Nitrate Hexahydrate Extra Pure 98% 500gm	LR-9850	Potassium Oxalate Ar 99.5% 500gm
LR-9160	Magnesium Sulphate Extra Pure (Heptahydrate) 99% 500gm	LR-9860	Potassium Oxalate Extra Pure 99% 500gm
LR-9170	Magnesium Sulphate Heptahydrate 99.5% Ar 500gm	LR-9870	Potassium Persulfate Extra Pure 98% 500gm
LR-9180	Magnesium Oxide (Light) Extra Pure 96% 100gm	LR-9880	Potassium Phosphate Dibasic Ar Anhydrous 500gm
LR-9190	Malachite Green C.I.No.42000 25gm	LR-9890	Potassium Phosphate Dibasic Extra Pure Anhydrous 500gm
LR-9200	Malachite Green Solution 1% Aqueous Sol 500ml	LR-9900	Potassium Sodium (+) Tartrate 500gm
LR-9210	Manganese (Ii) Chloride Ar (Tetrahydrate) 500gm	LR-9910	Potassium Sulphate Ar 99% 500gm
R-9220	Manganese (Ii) Sulphate Purified Monohydrate 98% 500gm	LR-9920	Potassium Sulphate Extra Pure 99% 500gm
LR-9230	Manganese Carbonate Extra Pure 500gm	LR-9930	Potassium Thiocyanate Ar 99% 500gm
LR-9240	Manganese Dioxide Tech.70% 500gm	LR-9940	Resorcinol Extra Pure 99% 250gm
LR-9250	May & Grunwald'S Solution Modified 500ml		
LR-9260	May And Grunwald'S Stain 25gm		
LR-9270	Mercuric Chloride 98% Extra Pure 250gm		
LR-9280	Mercuric Chloride Ar 99.5% 100gm		
LR-9290	Mercuric Iodide Red E.P.99% 100gm		
LR-9300	Methanol Ar 99.8% (Acetone Free) 2.50Lts		
LR-9310	Methanol99.8% For Hplc 2.50Lts		
LR-9320	Methyl Orange Indicator C.I.No.13025 25gm		

Code	Descripton	Code	Descripton
LR-10080	Sodium Carbonate Anhydrous Ar 99.9% 500gm	LR-10370	Starch Soluble Ar (Ex (Potato) 500gm
LR-10090	Sodium Chloride Ar 99.9% (Confirming To Ip Specif500gm	LR-10380	Sucrose Ar 500gm
LR-10100	Sodium Dichromate (Dihydrate) Extra Pure 98% 500gm	LR-10390	Sucrose Extra Pure 500gm
LR-10110	Sodium Fluoride 98.5% 500gm	LR-10400	Sudan Iii C.I.No.26100 25gm
LR-10120	Sodium Fluoride Ar 99% 500gm	LR-10410	Sulphosalicylic Acid Extra Pure 99% 500gm
LR-10130	Sodium Hydrogen Carbonate Ar 99.5% Confirming Tobp500gm	LR-10420	Sulphur Powder Extra Pure 98% 500gm
LR-10140	Sodium Hydrogen Carbonate Purified 500gm	LR-10430	Sulphuric Acid Ar 2.50Lts
LR-10150	Sodium Hydroxide Pellets Ar 500gm	LR-10440	Thiourea Gr 99% 500gm
LR-10160	Sodium Hydroxide Pellets Extra Pure 500gm	LR-10450	Thymol Blue Indicator Ar 25gm
LR-10170	Sodium Molybdate Ar (Dihydrate) 500gm	LR-10460	Thymol Blue Indicator Solution 500ml
LR-10180	Sodium Nitrate Ar 99.5% 500gm	LR-10470	Toluene Rectified 2.50Lts
LR-10190	Sodium Oxalate Ar 99.8% 500gm	LR-10480	Tri-Sodium Citrate Ar 500gm
LR-10200	Sodium Oxalate Extra Pure 99.5% 500gm	LR-10490	Universal Indicator Solution 1.00Lts
LR-10210	Sodium Phosphate Dibasic Anhydrous 500gm	LR-10500	Water For Hplc & Spectroscopy 2.50Lts
LR-10220	Sodium Phosphate Dibasic Anhydrous 500gm	LR-10510	Xylene Ar 99.5% 2.50Lts
LR-10230	Sodium Phosphate Dibasic Anhydrous 500gm	LR-10520	Xylene Rectified 98% Extra Pure 2.50Lts
LR-10240	Sodium Phosphate Dibasic Gr (Anhydrous) 99% 500gm	LR-10530	Zinc (Metal) Granular 99.5% 500gm
LR-10250	Sodium Phosphate Dibasic Gr (Anhydrous) 99% 500gm	LR-10540	Zinc (Metal) Granular Ar 99.9% 500gm
LR-10260	Sodium Phosphate Dibasic Gr (Dihydrate) 99.5% 500gm	LR-10550	Zinc Carbonate Basic 250gm
LR-10270	Sodium Sulphate Anhydrous Ar 99% 500gm	LR-10560	Zinc Chloride (Dry) Purified 97% 500gm
LR-10280	Sodium Sulphate Anhydrous Purified 500gm	LR-10570	Zinc Dust 325 Mesh 500gm
LR-10290	Sodium Sulphate Anhydrous Purified 500gm	LR-10580	Zinc Dust Ar 325 Mesh 500gm
LR-10300	Sodium Sulphide Flakes Extra Pure(Iron Free) 500gm	LR-10590	Zinc Nitrate (Hexahydrate) Purified 500gm
LR-10310	Sodium Sulphite Anhydrous Extra Pure 95% 500gm	LR-10600	Zinc Oxide 98% 500gm
LR-10320	Sodium Sulphite Ar (Anhydrous) 500gm	LR-10610	Zinc Phosphate 500gm
LR-10330	Sodium Thiosulphate Gr (Pentahydrate) Meets Bp/Usp500gm	LR-10620	Zinc Sulphate Ar (Heptahydrate) 99.5% 500gm
LR-10340	Sodium Thiosulphate Gr (Pentahydrate) Meets Bp/Usp500gm	LR-10630	Zinc Sulphate Pure (Heptahydrate) 99% 500gm
LR-10350	Sodium Tungstate Ar (Dihydrate) 99% 100gm	LR-10360	Starch Soluble (Ex Potato) 500gm

## HEMATOLOGY ANALYZERS REAGENTS

REAGENT	UNIT
Diluent	20 Litres
Rinse	5.5 Litres
Lyse	500 Mls
Lyse Leo I	1 litres
Lyse Leo II	400 Mls
Lyse LH	1 litre
Probe Cleanser	50 Mls
Probe Cleanser	17 Mls
EZ Cleanser	100 Mls
M 53 Cleaner	1 Litres
Control Normal	3 Mls
Control (L,H,N)	3 Mls each



At Crown Healthcare,  
We provide our customers with an entire range of  
laboratory solutions to suite their every study.



5-30



### DENTALSOLUTIONS

- Dental Units
- Imaging
- Digital Imaging System
- Orthodontics
- Endodontics
- Scalers
- Dental Compressors
- Dental Furniture

DENTAL SOLUTIONS

# DENTAL UNITS

Comfort, economic and Functional

## Dental Chairs-1000S

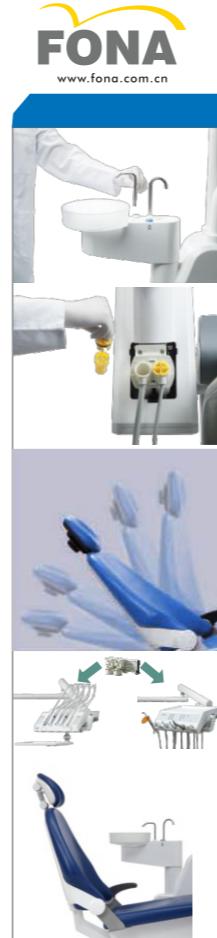

With backrest and seat safety system as well as the last chair memory position, the latest S series from FONA not only continue its heritage, but also enhance in both safe and convenient treatment operations.

### Water Unit

#### Standard Configuration:

- Superb suction efficiency
- All suction systems available
  - Air Venturi
  - Wet Suction
  - Semi-Wet Suction
  - Dry suction (S model)
- New innovative suction filters
- Removable cup filler and cuspidor rinse
- Water Heater Air Venturi System
- Air Water Separator

### Assistant Element

#### Standard Configuration:

- Different versions available
- 1,2,4 instruments positions
- Full Flexibility
- Great Access to patient

### Patient Chair

#### Standard Configuration:

- Deluxe Upholstery and Headrest
- Unified Upholstery interface
- Left Armrest always included
- Introducing new soft Upholstery
- Fresh colors
- Comfort stool

### Technical Specs:

- Operating Light
  - LED or Halogen
- Chair movement synchronized with light OFF/ON
- Monitor arm integrated in Light Arm
- Freely rotatable
- FONA Intra-Oral camera
- White LCD Monitor
- USB Connection to Computer
- Complete Multimedia Solution

### Dentist Element

#### Standard Configuration:

- Both Hanging and Whip Arm version
- Ergonomic regulation of spray and scaler
- power on side of Dentist Element
- New "Baustein" valves made in Germany

#### Available Upholstery Colours:

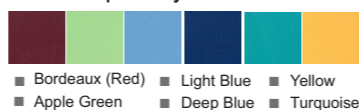

## Dental Chairs-2000L



FONA 2000 L combines enhanced ergonomics with stylish design and patient comfort. With its modular concept it offers great flexibility in configuration to meet your exact needs. Equipped with a brushless motor and complex hygiene solution, it is the ideal chair for your dental studio.

### Water Unit

#### Standard Configuration:

- Swivel And Removable Cuspidor Bowl
- Programmable Cup Filler and Bowl Rinsing System
- Fresh Water Bottle 1.5L
- Water Heater Air Venturi System
- Air Water Separator

### Technical Specs:

- Input power supply AC 100 V, AC 110 - 120 V,
- Water pressure 0,25 – 0,60 MPa / 2,5 – 6,0 bar
- Water flow  $\geq 2,5$  l/min
- Air supply pressure 0,55 – 0,75 MPa / 5,5 – 7,5 bar
- Air consumption  $\geq 70$  l/min without air venturi /  $\geq 130$  l/min with air venturi
- Suction machine  $\geq 500$  l/min with central suction
- Patient chair carrying capacity 165kg
- Patient chair movement range

### FEATURES

- Advanced anti-collision system
- Sensor controlled LED light
- Modern design and ergonomics
- Hygiene system including water decoupling and disinfection
- Enhanced safety for dentist and patient
- Up to 4 instruments with LED light

### Dentist Element

#### FONA 2000 L whip arm or hanging hoses dentist element

- Can be equipped with up to 6 instruments.
- Variable configuration is possible with selection including up to 4 high-speed instruments with light, 2 brushless motors, scaler with light including endo function, curing light and SPRAYVIT.

#### Splash stop system LED light

- Controlled by sensor or touch panel with 3D positioning for maximum visibility.

#### Patient comfort

- Integrated ErgoMotion and body contoured upholstery for excellent patient comfort.
- Adjustable assistant arm** Possibility of two different arm positions for greater working comfort.

#### Swiveling spittoon

- Easy to remove ceramic spittoon with built-in anti-collision system.

#### Foot cross-switch

- Hands-free patient positioning for ergonomic and hygienic workflow.

#### Available Upholstery Colours:



### Patient Chair

- GERMAN DESIGN AND ENGINEERING** Designed and engineered to meet highest ergonomic and safety standards.
- CONFIGURATION FREEDOM** Wide treatment center configuration choice to meet your needs.
- COMPLETE HYGIENE** FONA's hygiene package delivers a total solution to protect dentist, patient and environment from cross-contamination.

# DENTAL UNITS

Comfort, economic and Functional

## CADMUS Model:CAD5+

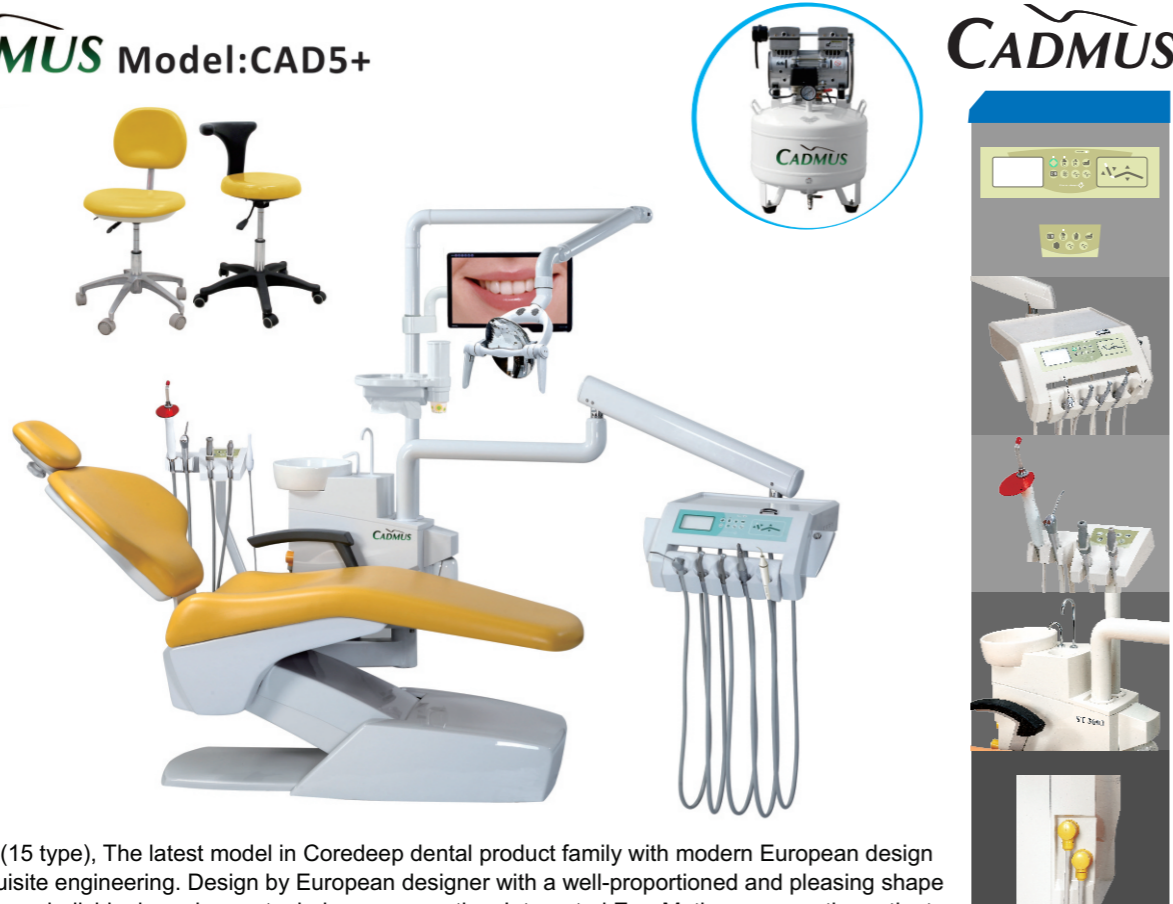

ST-3603(15 type), The latest model in Coredeep dental product family with modern European design and exquisite engineering. Design by European designer with a well-proportioned and pleasing shape to meet your individual requirements during your practice. Integrated ErgoMotion ensures the patient comfort. Convenient hands-free operation, flexible configuration possibilities and intuitive chair positioning. The solution for all your everyday needs integrating safety, ergonomic operation and configuration variety.

### Standard Accessories

Three way syringe, for cold and hot	1 PC each
Purified water bottle	1 PC
Powerful suction and saliva ejector	1 set each
Silence DC motor	2 PC
D C X-film viewer	1 set
Ceramic cuspidor	1 set
Operation light	1set
Assistant stool	1 PC

### Option accessories

- Intra Oral camera system
- TOP mounted
- High speed air turbine handpiece
- Low speed air motor handpiece
- LED curing light
- Scaler

### Assistant Element

#### Standard Configuration:

- Suction filter system
- Position 1:** three way syringe
- Position 2:** HVE
- Position 3:** saliva ejector

#### Options

- Assistant control panel

### Technical Specs:

- Power supply:220V,50Hz/60Hz
- Air pressure:>0.55MPa
- Water pressure:0.2~0.4MPa

### Features

Work Unit Control Panel  
Assistant Unit Control Panel  
Dentist Work Unit  
With drop-proof angle and can be equipped with up to 5 instruments including scaler and handpieces.  
Assistant Unit  
4 holders assistant unit with anteroposterior position design equipped with standard syringe, saliva ejector and strong suction, also can be optional equipped with curing light.  
Ceramic Cuspidor  
Enameled ceramic is safe and easy to use. Removable ceramic cuspidor bowl makes the infection control and cleaning simple and fast. Built-out and independent filter for each suction hose for better performance and easy cleaning.

### Available Upholstery Colours:

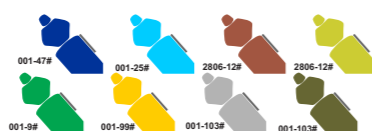

# IMAGING OPG

Clarity for better diagnostics

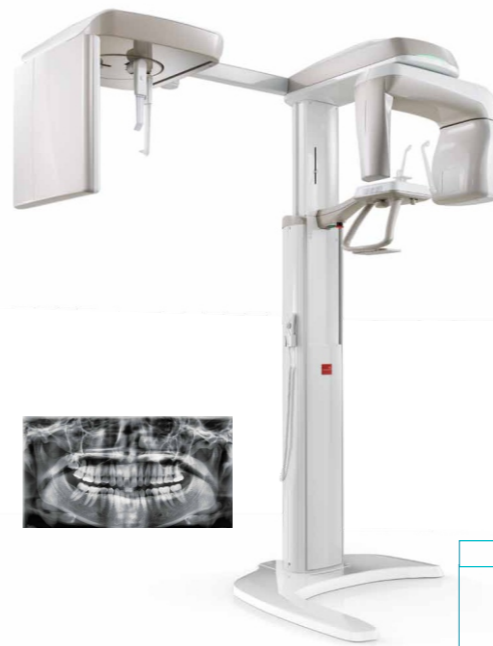

### Superior Image Quality

- Optimal image for accurate diagnosis
- Two Built-in Sensors**
- Specialized sensors for Pano & Ceph
- Streamlined workflow and prolonged lifespan of sensors

### User-friendly Software, EzDent

It is the complete solution for your consultations

### Modern and Compact Design

- Raise design value of your clinic
- Save installation space in your practice

### New standard of panoramic image

Clear and sharp panoramic image brings you better diagnostics. Enhanced details especially in the anterior and dental roots can be viewed.

These consistently high quality images will become the new standard of panoramic imaging.

Make your diagnosis easy and efficient with various capture modes

### Bitewing mode



### TMJ mode

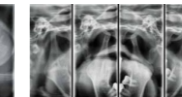

PANO EXAMINATION	Narrow / Normal Wide / Child	Standard / Right / Front / Left
	Orthogonal	Orthogonal Standard / Right / Front / Left Bitewing Standard / Right / Front / Left
SPECIAL EXAMINATION	Normal	TMJ LAT Open / Close TMJ PA Open / Close Sinus LAT / PA



## Extraoral imaging – FONA XPan 3D



3D CBCT system - complete view for accurate diagnostics

- 8.5 x 8.5 cm FOV in 10 sec.
- 3D + PANO High Image quality
- 2 in 1 compact design

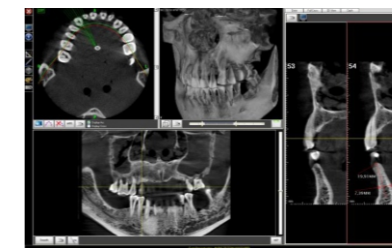

Contact Us for Demo Presentation

# DIGITAL IMAGING SYSTEMS

Digital Clarity for better diagnostics



## Mobile X-Ray Unit

- Fashion Design
- Stable base
- Strong column
- Stretchable arm
- Multi-function timer
- Easy-operational handset

### Specification

- Power Voltage: AC220 ± 10%
- Frequency: 50/60Hz
- Electric plug: Three-core (International / European standard)
- Ultimate Capacity: 900VA
- Electric Current: 4AFuse: 6.3A
- Focus: 0.8mm
- Rated High Voltage: 70KV ± 10%
- Tube-Head Current: 7mA ± 15%
- Anode Angle: 19°
- Load Cycle: 1/60
- Half Value Layer: 1.6mmAL under 70KV
- Inherent Filtration: ≥2.1mm AL
- Radiation Leakage: < 0.07mGy/h
- Exposure Time: 0.06-2.00s

Also Available in Wall Mount



## Standard X-ray System ESX Series

The ESX standard x-ray is an intraoral x-ray imaging system which offers safety, reliability, and greater functionality. It also features a multi-directional full-swivel revolution. The tube head revolves freely around the sphere, so practically any position can be achieved, including complete vertical movement.

### What is the ESX?

DC type high frequency intraoral x-ray system Intuitive & easy to use operating panel Smart & reliable design for easy & steady use Automatic & optimal capture setting Support both of film and digital sensors

*Flexible installation ( chair / Wall type)*



## Intraoral sensors

EzSensor provides consistently high resolution and clear images for accurate diagnosis and treatment planning.

### Various Sizes (1.0 / 1.5 / 2.0)

Select the right sized sensor from the three size options to increase patient comfort.

### Ergonomic

The EzSensor has a slim design with rounded corners for easy positioning to ensure patient comfort.

### Durability

The EzSensor's unique design makes itself extremely durable. The exterior is made of rugged aluminum and the interior is designed to absorb the external shock. Furthermore, a reinforced, flexible cable attachment protects the sensor from excessive bending.



# ORTHODONTICS

Straight wire application system



## Mini-Twin 10 Kits Mini 2000



The Mini-Twin brings a rhomboid design to a Straight-Wire appliance system. Thirty percent smaller than a standard Twin, the Mini-Twin is designed to give you the control you demand in an appliance that is more esthetic and comfortable for your patients.

Mini-Twin appliances feature Ultra-Lock high-retention pads on both upper and lower bicuspids, providing increased bonding surface and minimizing bond failure. The vertical scribe line aligns precisely with the crown-long axis, simplifying accurate bracket placement. As is the case with all Straight-Wire Appliances, the arch wire slot of Mini-Twin appliances is engineered to align with the horizontal axis of the tooth. Mini-Twins are available in Andrews and Roth\* prescriptions, and are fully interchangeable with any other Straight-Wire Appliance system.

Options include hooks/no hooks, gingival offsets on bicuspids, super torque on upper anteriors and surgical sets.

## DAMON Q



### • Quintessential Performance and Reliability

- Four walls with optimized slot depths or improved rotation and fast tooth movement
- Stainless steel 17-4 metal-injection molded construction for strength and durability

### • A Quantum Leap in Efficiency

- Horizontal and vertical auxiliary slots for greater versatility
- Rhomboid-shaped bracket and pad and vertical scribe line for smile arc enhancement

### • Quick and Easy Wire Changes

- Innovative SpinTek™ slide with chamfered lingual leading edge facilitates easy slide closure and wire engagement

### • Quality Comfort & Aesthetics

- Small bracket sizes with smooth, rounded corners help prevent occlusal interference while offering greater comfort and aesthetics



# ENDODONTICS

Functional and easy to use

## FKG Rooter Motor NITI ADVENTURE



- + Rooter Motor
- + Mixed K Files (6-25) x 5
- + Assorted Gates x 1
- + Guta Percha 4% Size 30 x 1
- + iRACE Sequence x 7
- + iRACE PLUS x 5
- + Guta Percha 4% Size 25 x 1
- + Paper Points 4% Size 30 x 1
- + Paper Points 4% Size 25 x 1
- + XP Endo Finisher x 2
- + Barbed Broaches (25-60) x 2
- + Endo Organizer with ruler x 1
- + Totalfil BC Sealer x 1



## NSK Advanced Digital Apex Locator



### Precision Digital Apex Locator

NSK's new digital apex locator insures great accuracy in all canal conditions and eliminates problems apparent in other Apex Locators which use analogue signals.

The NSK iPex multi-frequency measuring software technology filters the irrelevant signals that can appear in curved canals or under other extraordinary circumstances.

iPex also automatically select the best possible combinations of frequency to meet patient's canal condition.

- Instant accurate measurement of canal length
- User friendly interface
- Large Hi-contrast LCD screen for easy monitoring
- Compact and smart design
- Audible warning system
- Auto power shut-off
- AAA battery operation
- No manual calibration necessary



# SCALERS

High Quality and reliable



## JADE Piezo Scaler

High quality and reliability thanks to the experience and competence of Swiss engineering for this powerful and clinically safe Piezo scaler

### Swiss technology

- Well-proven Swiss Piezo system
- Permanent feedback control and real-time power adjustments for maximum safety and comfort
- Precise settings and power delivery for scaling, periodontal, endodontic and restorative treatments
- Up to 32,000 linear instrument movements per second

### Product features

- Powerful Swiss module with minimal operating noise
- Extremely compact Swiss design
- Ultraslim lightweight handpiece
- Large selector for effortless power control

### Includes

- Jade device with fully sterilizable quality handpiece
- 5 instruments for scaling and periodontal treatments (G1, G2, G4, P1, P3)
- Diaphragm pump and 1 bottle of 350ml (Jade S2)
- One step foot pedal and external power supply



## Varios 970 iPiezo engine



## Curing Light

*new* NSK presents its latest  
**Ultrasonic Scaler**  
Powered by iPiezo engine

Slim ergonomically designed handpiece guarantees excellent accessibility, high visibility and comfortable operation.

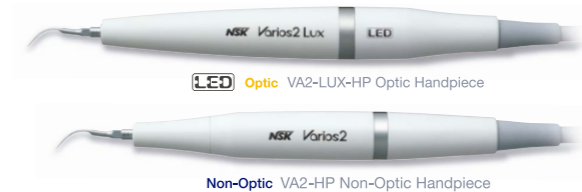

## DEEP BLUE®



### Product features

- Ergonomic cordless lightweight design of only 90g
- Slim shape for enhanced visibility
- Two power modes and seven time options for adapted and precise settings
- Digital display for accurate time setting
- Powerful battery to perform over 600 ten-second cures without the need to recharge
- Automatic switch-off mode after three minutes of inactivity

### Includes

- DEEP BLUE® LED curing light with fully sterilizable light guide
- 1 removable protection lens
- 1 rechargeable battery integrated
- Charging station or external power adaptor



# DENTAL COMPRESSORS

Powerful, durable and long lasting



## Cadmas Air Compressor C200/1100W

Silent, Oilless  
Modified motor: 2 relays inside motor,  
Voltage: 170v~240v  
Two motors can work at the same time or separate

### Specification:

Power: 2x550W. Air Flow: 220L/min  
Voltage: 220V/50HZ. Tank: 55L



## Dental Air Compressors

Dental Oilless series  
Power Oilless Series  
Shark Oilless Series

# DENTAL FURNITURE

Multi-Functional Units



## MASTER C3700



Made in Italy

## Suction Unit

Liquid Ring Aspiration

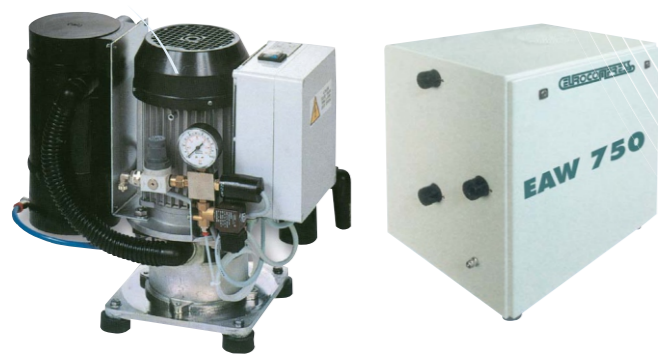

Semi-Dry Suction Unit

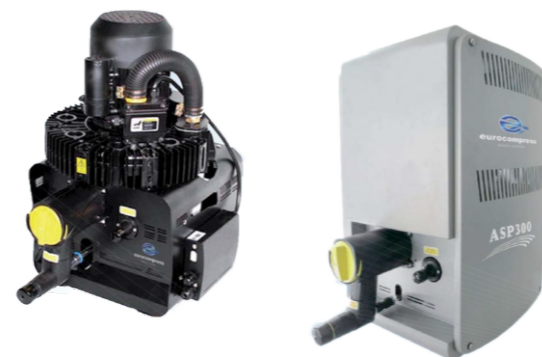



# PHYSIOTHERAPY

5-30



## PHYSIOTHERAPY

- Wheel Chairs
- Commode Chairs
- Crutches
- Walking Aids
- Walking Frames
- Orthopaedic Supports

# WHEEL CHAIRS

Foshan

## WC-809-46 Standard Economical

Chromed steel frame  
Fixed armrest  
Fixed footrest  
Solid Castor  
Solid rear wheel



## WC-809B-46 Standard

Chromed steel frame  
Fixed armrest  
Fixed footrest  
Solid Castor  
Solid Mag rear wheel



## FS902C Orthopedic Whee

Chromed steel frame  
Detachable desk armrest  
Elevating footrest  
TPR castor  
Pneumatic rear wheel



## FS802-35 Standard Economical

Chromed steel frame  
Fixed armrest  
Fixed footrest  
Solid Castor  
Solid rear wheel



# COMMUNE CHAIRS



**WCC-893**  
Commode Chair  
Model 893  
without Wheels



**WCC-692**  
Powder coating steel frame  
Flip down armrest  
Detachable footrest  
Solid rear castor with lock  
Plastic Commode seat



**MODEL FS 609**  
Foldable chromed steel frame  
U shape commode seat  
Fixed armrest & footrest  
Solid castor & rear wheel



**WCC-002**  
Shower Chair

# CRUTCHES

SHOULDER & ELBOW - Foshan



**EC-925L**  
Shoulder  
Crutches 925L



**EC 001**  
Elbow Crutches  
FS 933I

# WALKING STICKS

FOSHAN



**WC-908-46**



**WA-932**



**WA-926**



# WALKING FRAMES

Foshan



**913 Without Wheels**

<b>WA-913</b>	Walking Frame Model 913 without wheels
<b>WA-915</b>	Walking Frame Model 915 without wheels
<b>WA-918</b>	Walking Frame Model 918 with wheels



**918 With Wheels**

<b>SP-640</b>	Spare Castor(wheels) 5.5 with brake
<b>SP-650</b>	Spare Castor (wheels) 5.5 without brake
<b>SP-641</b>	Spare Pneumatic Wheel size 24 inch for wheelchairs
<b>SP-642</b>	Spare Solid Wheels size 24 inch for wheelchair
<b>SP-560</b>	Invalid Crutches Tips



# KNEE SUPPORTS

Stretchable & Breathable



## Elastic Knee Support

- Item Code:** A7-002  
**Color:** Beige  
**Size:** S,M,L,XL,XXL
- Prevents sports and work related knee injury.
  - Give a proper support on compression.
  - Relieve pain and swelling.
  - Speeds up recovery.



## Athletic Knee Supports

- Item Code:** C7-005  
**Color:** Blue **Size:** S,M,L,XL,XXL
- Ideal to support, stabilize the knee.
  - Prevents knee injury during sports or work activity.
  - Provides heat therapy.
  - Help to speed up recovery.



# KNEE SUPPORTS

Stretchable & Breathable



## Athletic Patellar Supports

**Item Code:** C7-006

**Color:** Blue

**Size:** S,M,L,XL,XXL

- Ideal to support, stabilize the knee.
- Prevents knee injury during sports or work activity.
- Open patella can position the knee.
- Provides heat therapy.
- Helps to speed up recovery.



## Airprene Knee Support

**Item Code:** D7-001

**Color:** Black

**Size:** S,M,L,XL,XXL

Prevent knee injury during work or sports activity.

Provide a proper stabilization, & compression.

Improves blood circulation and keep knee warm.

Airprene provides good ventilation.



## Neoprene Knee Supports W/4 stays

**Item Code:** C7-001

**Color:** Black

**Size:** One Size

Made of good quality neoprene, Nylon materials, and 4 pieces of soft stays.

- Surface fabric allow hook to adjust the size to fit knee snugly.
- Open patella design can position the knee and avoid displacement.
- A circular pad on the knee patella provides extra support & stabilization.



## Neoprene Open Knee Brace W/ Hinge

**Item Code:** C7-002

**Color:** Black

**Size:** S,M,L,XL,XXL

- Aluminum hinge provide good stabilization to the injured knee.
- Additional pads to support the knee patella.
- One panel and opening shape easy to wear.

# KNEE SUPPORTS

Stretchable & Breathable



## Neoprene Knee Support W/ Spiral Stays

**Item Code:** C7-004

**Color:** Black

**Size:** S,M,L,XL,XXL

- Prevents sports & work related knee injury.
- Lateral spiral stays provide good stabilization.
- Relieve pain and swelling & speeds up recovery.



## Airprene Knee Supports

**Item Code:** D7-002

**Color:** Black **Size:** One Size

- Prevent knee injury during work or sports activity.
- Provide a proper stabilization, & compression.
- Improves blood circulation & keep knee warmth.
- Airprene can provide good ventilation.
- Designed for all knee size



## Superior Airprene Knee Sleeve

**Item Code:** D7-009

**Size:** S, M, L, XL, XXL

- Stabilize the weak or injured knee or prevent a knee injury while working.
- Open patella design can be worn in position and avoid the displacement.
- The pad around the patella to protect the patellar ligament and soft tissue.



## Superior Airprene Knee Brace with hinge

**Item Code:** D7-011

**Size:** S, M, L, XL, XXL

- It is ideal to support ligament strains, sprain, torn ligament or any instability knee.
- 3D sleeve design fit the knee joint snugly.
- Open patella can fix the brace in position.

# KNEE SUPPORTS

Stretchable & Breathable



## Superior Airprene Open Knee Wrap

**Item Code:** D7-013

**Size:** One Size

- Stabilize the weak or injured knee or prevent the knee injury while overuse.
- Surface fabric can be caught by hook to adjust the size easily.
- The pad around the patella to protect the patellar ligament and soft tissue.

# KNEE SUPPORTS

Stretchable & Breathable



## Superior Airprene Ankle Sleeve

**Item Code:** D9-004

**Size:** S, M, L, XL, XXL

- Ideal for weak or injured ankle or prevent injury.
- Open toe and heel can fix the ankle support in position and provide comfort.

# ANKLE SUPPORTS

Speedy Recovery



## Ankle Supports

**Item Code:** B9-002

**Color:** Beige

**Size:** S,M,L,XL,XXL

- Prevents ankle injury during sports or work activity.
- Accelerate blood circulation.
- Provides heat therapy.
- Help to speed up recovery.



## Neoprene Ankle Supports

**Item Code:** C9-001

**Color:** Black **Size:** S,M,L,XL,XXL

- Prevents ankle injury during sports or work activity.
- Provides heat therapy.
- Accelerate blood circulation.
- Helps speed up recovery.



## Athletic Ankle Supports

**Item Code:** C9-002

**Color:** Blue

**Size:** S,M,L,XL,XXL

- Prevents ankle injury during sports or work activity.
- Provides heat therapy.
- Accelerate the blood circulation.
- Helps to speed up recovery.



## Elastic Ankle Support

**Item Code:** A9-009

**Color:** Beige

**Size:** S,M,L,XL,XXL

- Prevents sports and work related ankle injury.
- Relieve pain and swelling.
- Speeds up recovery.



## Ankle walker with Pull-Lock ROM

**Item Code:** O9-012

**Size:** S,M,L,XL

**Height:** 16"

- Stabilize the ankle, foot and lower leg after post-operative or fracture to decrease pain and edema as rehabilitation.
- Wider Rocky bottom sole can help to shift the step easily & enhance comfort.
- Two lateral Pull-Lock ROM hinges can lock the angle quickly and easily.
- Range of motion settings are between 0° to 120° flexion & 0 to 30° extension.
- High density foam as inner to provide better cushion

# Thigh/Calf Supports

Simple and Easy to wear



## Elastic Thigh Support

**Item Code:** A6-002

**Color:** Beige

**Size:** S,M,L,XL,XXL

- Prevents sports and work related thigh injury.
- Relieve pain and swelling.
- Speeds up recovery.



## Neoprene Calf Supports

**Item Code:** C8-001

**Color:** Black **Size:** S,M,L,XL

- Prevents calf muscular injury during sports or work activity.
- Provides heat therapy.
- Accelerate blood circulation.
- Help to speed up recovery.



## Universal Thigh & Calf Splint

**Item Code:** O6-008 **Size:** one size

- Ideal to immobilize the postoperative or fracture thigh or calf.
- Aluminum stays provide stabilization
- Soft foam cushioning
- Simple and easy to wear.



# ARM SLING

Enhanced Comfort



## Arm Sling

**Item Code:** O4-003

**Color:** Blue **Size:** S,M,L,XL

- Good immobilization for the post-traumatic arm & shoulder.
- Reduce pain & swelling.
- The strap is adjustable.
- Additional foam pad can enhance comfort.



## Arm Sling W/ Swathe

**Item Code:** O4-021

**Size:** one size

- Ideal for immobilization of the dislocation, post-operative or fracture arm or shoulder.
- High density foam to give more cushion & comfort.
- Two straps with padding criss cross the back around to forearm to reduce some unnecessary pressure which relieve the pain from shoulder.
- Swathe with hook closure can secure the fit and avoid the dislocation of arm.



# CERVICAL COLLAR

Stability meets Comfort



## 2-Piece Plastic Collar

- Item Code:** O1-011  
**Color:** White **Size:** S,M,L,XL
- 2-piece construction easy to adjust the height
  - Plastic material with perforated vents
  - Padding on the border enhance comfort



## Pediatric Soft Collar

- Item Code:** A1-002  
**Color:** Beige or White **Size:** S,M,L
- Height:** 5cm,M:6cm,L:7.5cm
- Immobilizes the injured neck
  - High density foam provides good cushioning and stabilization.
  - Adopts the cotton materials are friendly to the skin.
  - Speed up the recovery.



## Forming Cervical Collar

- Item Code:** O1-001  
**Size:** S/M, L/XL
- Lightweight molded foam collar.
  - Tracheostomy hole is in front



## Adult Soft Collar

- Item Code:** A1-001  
**Color:** Beige or White **Size:** S,M,L,XL
- Immobilizes the injured neck
  - High density foam provides good cushioning and stabilization.
  - Adopts the cotton materials are friendly to the skin.
  - Speed up the recovery.

# Back SUPPORTS

Relieves Back pain



## Airprene Waist Belt W / 3 stays

- Item Code:** D5-001  
**Size:** One Size  
**Height:** 23.7 cm
- Perforated neoprene (Airprene) can provide ventilation and keep body warmth.
  - 3 flexible metal stays support the back to relieve the back pain.
  - The front contour is very comfortable to wear, can also avoid bulge while sitting.
  - The surface fabric can be loop side and allow fit the most of waists.



## Elastic Back Support

- Item Code:** A5-006  
**Color:** Beige  
**Size:** S,M,L,XL,XXL  
**Height:** 26.3 cm
- This product designed to prevent the injury or relieve the pain from back injury or sprain.
  - It is made of high elastic straps which can allow good ventilation for the skin.
  - Prolong wearing can help to accelerate the blood circulation, speed up recovery, correct the posture, and relive the back pain.



## Lumbar Support

- Item Code:** A5-008  
**Color:** Brown  
**Size:** S,M,L,XL,XXL  
**Height:** 23 cm
- Relieves back pain & speed up recovery.
  - Correct the posture effectively.



## Breathable Lumbar Support W/ 6 Stays

- Item Code:** A5-067  
**Color:** Beige  
**Size:** S,M,L,XL,XXL  
**Height:** 26.3 cm
- 4 steel stays at back can enhance support and correct the posture to relieve the backache.
  - 2 PP stays at lateral back can provide flexible support to contour waist and gain comfort.
  - The open stays pouches design allow the stays can be removable according to patients' demand.



# Back SUPPORTS

Relieves Back pain



**Lumbar Support w/ 4 stays**  
**Item Code:** B5-011  
**Color:** Beige  
**Size:** S,M,L,XL,XXL  
**Height:** 25.7 cm  
 • Uses unique breathable elastic straps and airmesh material combination to allow free ventilation.  
 • The two side-pulls can be adjusted to fit snugly into any waist.  
 • 4 highly flexible metal stays support the back.  
**Price: Kes.2,710.00**



**Neoprene Back Support**  
**Item Code:** C5-015  
**Size:** S/M, L/XL, XXL  
**Height:** 24 cm  
 • Neoprene keeps body warm & accelerates blood circulation to provide heat therapy which relieves backache efficiently.  
 • Corrects the posture.  
 • Has additional side-puller which provides more compression.  
 • Inner cotton fabric can absorb moisture to enhance comfort.  
**Price: Kes.3,530.00**



**Elastic Back Support**  
**Item Code:** A5-007  
**Color:** Beige  
**Size:** S,M,L,XL,XXL  
**Height:** 26 cm  
 • Relieves back pain & speeds up recovery.  
 • Corrects the posture effectively.  
**Price: Kes.2,410.00**



Relieves Back Pain.....

# Back SUPPORTS

Relieves Back pain



## Name Elastic Posture Brace

**Item Code:** O2-007  
**Color:** Beige  
**Size:** S,M,L,XL,XXL  
 Ideal to prevent and support the back caused by incorrect posture.  
 • Made of high quality breathable elastic straps which are easy to adjust for maximum comfort.  
 • Interior cotton is very friendly to the skin & absorbs moisture.  
 • It can provide a proper compression & good stabilization to relieve the backache & correct posture.



## Magnetic Back Brace

**Item Code:** C2-003  
**Size:** S, M, L, XL, XXL  
 • Ideal to prevent and support the back caused by incorrect posture.  
 • The breathable "EASY FIT" elastic loop strap is free to adjust the size for a perfect fit.  
 • Magnets can offer Far-Infrared rays to accelerate the blood circulation and keep the body warm to relieve the pain.

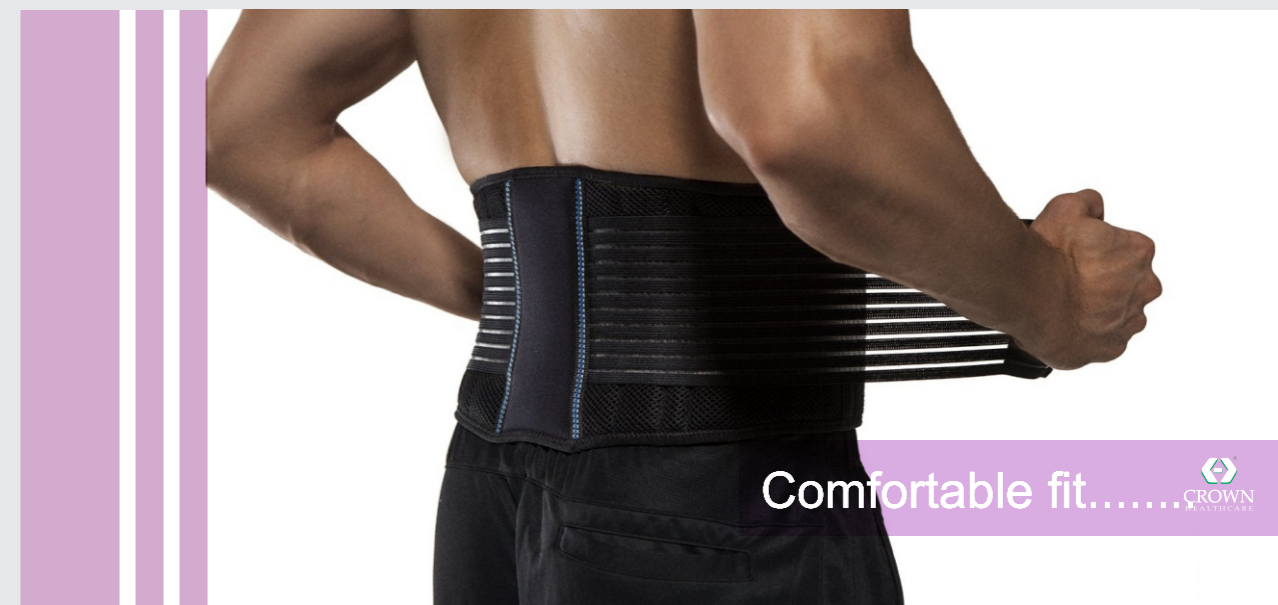

Comfortable fit.....

# Thumb/Wrist/Shoulder

## Speedy Recovery



### Breathable Wrist Splint

- Item Code:** A4-003  
**Color:** Grey  
**Size:** S,M,L,XL
- The breathable, soft material makes a pleasure to wear, & fit the wrist comfortably.
  - The aluminum stay and the Velcro could be adjusted for fit easily.
  - This brace is suitable for the post operative wrist, carpal tunnel syndrome, wrist sprain, and wrist arthritis.

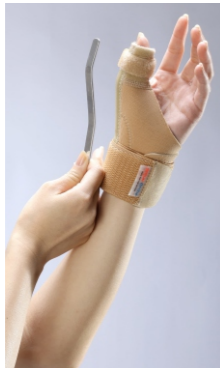

### Wrist Thumb Splint

- Item Code:** C4-018  
**Size:** one size  
**Specification Side:** Universal for both hands
- Made of neoprene to provide heat therapy to accelerate the blood circulation.
  - The aluminum stay can be bended for proper fit to immobilize the thumb in the position.
  - Additional elastic loop straps wrap the wrist to give firmly fit and support.
  - The inner foam padding give thumb more comfort and cushion.



### Elastic Palm with Wrist Support

- Item Code:** A4-032  
**Color:** Beige or White  
**Size:** S,M,L,XL,XXL
- Prevents sports and work related wrist injury.
  - The palm and thumb opening fix the support in position
  - Relieve pain and swelling.
  - Speeds up recovery.



### Wrist Splint

- Item Code:** O4-002  
**Color:** Black  
**Size:** S,M,L,XL
- Good immobilization for the post-traumatic wrist.
  - Aluminum stay and plastic stays stabilizes wrist in the position.
  - The breathable material is very comfortable to wear.
  - The foam padding provides the soft cushioning.



### Airprene Shoulder Support

- Item Code:** D2-003  
**Size:** S/M, L/XL
- Made of good quality perforated neoprene (Airprene), nylon.
  - Prevents and support sports and work related shoulder or clavicular injury.
  - Universal design is available for left & right shoulder.
  - The shape design can fit the shoulder snugly which can avoid the bulge while doing the exercise.

# Compression Stockings



### Classic Under Knee Close Toes

- Item Code:** A8-002  
**Color:** Black & Beige  
**Size:** S,M,L,XL,XXL  
**Specification:** 15-20 mmHg, 20-30 mmHg, 30-40 mmHg
- Adopted quality yarns and height denier elastic fibers to give optimum & comfort fit.
  - Soft and wider band for UNDER-KNEE & THIGH-HIGH to provide more comfortable fit.
  - Has more elasticity in the toes parts and wider toe for closed toe.



### Classic Thigh High Close Toes

- Item Code:** A6-005  
**Color:** Black & Beige  
**Size:** S,M,L,XL,XXL  
**Specification:** 15-20 mmHg, 20-30 mmHg, 30-40 mmHg
- Reinforced heel to prevent slippage & help to fit snugly.
  - 4-way stretches construction very easy to put on and off.
  - Very soft touching & friendly to the skin.

# Compression Stockings



## Name Classic Pantyhose

**Item Code:** A5-051  
**Color:** Black & Beige  
**Size:** S,M,L,XL,XXL  
**Specification:** 15-20 mmHg, 20-30 mmHg, 30-40 mmHg  
 • Adopted quality yarns and height denier elastic fibers to give optimum and comfort fit.  
 • Very soft touching and friendly to the skin.  
 • Comfort and stylish to achieve medical efficiency.



## Name Man Sock , close toes

**Item Code:** A8-008  
**Color:** Black  
**Size:** S,M,L,XL,XXL  
**Specification:** 15-20 mmHg, 20-30 mmHg, 30-40 mmHg  
 • Ribbed style Wider toes and more elastic on the toes for comfort fit.  
 • Wider top band for fit comfortably.  
 • 4-way stretch is very pleasant to wear.  
 • Reinforced heel to prevent slippage and provide snugly fit.



Friendly & Soft to the touch.....



REFRIGERATION



5-30

## REFRIGERATION

- Pharmacy Fridges
- Solar Vaccine Fridges
- Ice Lined Fridges
- Blood Bank Fridges
- Deep Freezers Fridges
- Blood Transport Boxes
- Biological Safety Cabinets



# REFRIGERATION

Constant temperature control



## 2°C~8°C/-2°C~-4°C

Pharmaceutical Refrigerator with Freezer



### Refrigerator & Freezer Combination, Separately Control

#### Excellent Performance

- Refrigerator 2~8C, freezer -20~-40C

#### Reasonable Structure

- Large refrigerator; stainless steel, arch out door for convenient clean

#### Key Function

- USB port, can record the temperature in one month automatically
- Separate display of refrigerator and freezer, easy observation
- Remote alarm and monitor in internet (optional)
- Divisible drawers and shelves for different items storing
- Multi-malfunction alarms, ece cautionary alarm

#### HYC02232

Voltage(V/Hz)	Power(W)	Temp. range(°C)	Capacity(L)	Net /Gross Weight(Kg)	Shelves/Drawer
220/50	400	2~8/-20~-40	Refrigerator185 Freezer97	145/160	4/2
Exterior Dimension(mm)			Interior Dimension(mm)		Container Load (sets)
Refrigerator / Freezer					
W	725	605/515	875		12/26/26
D	620	460/430	770		
H	1810	720/440	1920		



Constant Temperature Control



## 2°C~8°C Pharmacy Refrigerator



#### HYC-68A

Voltage(V/Hz)	Power(W)	Temp. range(°C)	Capacity(L)	Net /Gross Weight(Kg)	Shelves/Baskets
220/50 120/60	84	2~8	68	38/40	2/1
Exterior Dimension(mm)		Interior Dimension(mm)		Packing Dimension(mm)	
W	500	D	425	522	
D	490	H	351	620	
H	640		314	690	
					Container Load (sets)
					20'/40'/40'H
					108/228/228



#### HYC-260

Voltage(V/Hz)	Power(W)	Temp. range(°C)	Capacity(L)	Net /Gross Weight(Kg)	Shelves/Inner door
120/60 220/50 220/60	340	2~8	260	88/100	4/-
Exterior Dimension(mm)		Interior Dimension(mm)		Packing Dimension(mm)	
W	620	D	555	705	
D	655	H	460	715	
H	1720		1065	1900	
					Container Load (sets)
					20'/40'/40'H
					24/48/48



For your Pharmacy or Lab



# REFRIGERATION

Constant temperature control

**Haier**  
Inspired living

## -25°C Vaccine & Icepack Freezer



Model	HBD-116	HBD-286
Vaccine storage capacity	92L	90L
Gross volume	121L	198L
Gross weight (kg)	58	82
Ambient temperature	<43°C	<43°C
Compressor	Danfoss compressor	Danfoss compressor
Refrigerant	R134a	R134a
Exterior Dimensions( mm) (H×W×L)	832×755×630	832×1243×630
Packing Dimensions (mm) (H×W×L)	950×837×760	950×1325×760
Container load( sets) 20'/40'/40H	42/84/126	24/54/81
Power Consumption: stable running	0.38KWh/24h	4.36KWh/24h

## 2°C~8°C Ice-Lined Refrigerator



Model	HBC-70	HBC-200	HBC-340
Vaccine storage capacity	45L	90L	200L
Gross volume	71L	198L	340L
Gross Weight(kg)	70	115	165
Ambient temperature	10°C-43°C	10°C-43°C	10°C-43°C
Compressor	Danfoss compressor	Danfoss compressor	Danfoss compressor
Refrigerant	R134a	R134a	R134a
Exterior Dimension ( mm) (W×D×H)	610×406×360	610×976×366	1644×650×846
Packing Dimension (mm) (W×D×H)	880×756×760	880×1325×760	1764×770×1046
Container load (sets)20'/40'/40H	42/90/135	24/54/81	18/36/36
Holdover time t 43°C	>27H	>31H	>37H
Power consumption:able running	0.64 KWh/24h	1.34 KWh/24h	2.86KW.h/24h
Power consumption: ool down test	2.4 KWh/24h	4.01 KWh/24h	4.32KW.h/24h

## 2°C~8°C Solar Vaccine Freezer



### HBC 60

Solar driven vaccine refrigerator: HBC-60 is driven by the sun, directly from solar panels. This appliance does not need battery storage or fuel for power.

It is designed for the region with enough sunshine and poor electricity.

Driven by solar panels without any battery, this refrigerator will not bring any negative impact to the environment.

#### Features:

- Driven by solar power, environment friendly
- No battery for storage of power
- No need for power and fuel, low cost
- Digital display of temperature
- Easy installation
- Easy maintenance, only the solar panels need to be maintained
- Stainless steel interior liner
- Lock design, keep safety of vaccines



# REFRIGERATION

Constant temperature control



## -86C ULTRA LOW TEMPERATURE FREEZER



DW-86L388

Voltage(V/Hz)	Power(W)	Temp. range(°C)	Capacity(L)	Net /Gross Weight(Kg)	Shelves/Inner door
220/50	1000	-40~-86	388	255/276	3/4

Exterior Dimension(mm)			Interior Dimension(mm)		Packing Dimension(mm)		Container Load (sets)	
W	915		620		952		20'/40'/40'H	
D	870		550		924			
H	1970		1300		2130		12/24/24	

Model	Dimension(W*D*H)	Rack Quantity	Box Quantity	Sample Quantity
2 inch stainless steel rack4*3	138*409*234	16	192	15552

Calculated based on 9\*9 box



DW-86L490

Voltage(V/Hz)	Power(W)	Temp. range(°C)	Capacity(L)	Net /Gross Weight(Kg)	Shelves/Inner door
220/50	1100	-40~-86	490	295/335	3/4

Exterior Dimension(mm)			Interior Dimension(mm)		Packing Dimension(mm)		Container Load (sets)	
W	860		590		902		20'/40'/40'H	
D	900		630		1004			
H	1970		1310		2130		12/24/24	

Model	Dimension(W*D*H)	Rack Quantity	Box Quantity	Sample Quantity
<b>Upper chamber</b>				
2 inch stainless steel rack5*4	138*544*287	8	160	12960
2 inch stainless steel drawer rack5*4	140*554*289	8	160	12960
3 inch stainless steel rack3*4	138*544*260	8	96	7776
3 inch stainless steel drawer rack3*4	140*554*261	8	96	7776
<b>Lower chamber</b>				
2 inch stainless steel rack4*4	138*544*234	8	128	10368
2 inch stainless steel drawer rack4*4	140*554*236	8	128	10368
3 inch stainless steel rack3*4	138*544*260	8	96	7776
3 inch stainless steel drawer rack3*4	140*554*261	8	96	7776

Calculated based on 9\*9 box

4/22°C

Blood Transport Box



HXC-80

Voltage(V/Hz)	Power(W)	Temp. range(°C)	Capacity(L)	Net /Gross Weight(Kg)	Shelves/Baskets
DC12/24	DC75	4±1.5	80	58/65	-/4
AC100-240	AC105	Or22±2			
/50~60					

Exterior Dimension(mm)			Interior Dimension(mm)		Packing Dimension(mm)		Container Load (sets)	
W	1060		570		1145		20'/40'/40'H	
D	550		350		615			
H	850		580		900		36/76/76	

This product is suitable to be installed on ambulance, blood transportation vehicle and vaccine transportation vehicle of medical organizations. It can be used in extremely hostile environment. Ambient temperature ranges from -2 C to 43 C and humidity can be above 80%



5-30



### GASSOLUTIONS

- Vision Aire
- Sure Flow
- Newlife Intensity
- Free Style
- Pendants, Flowmeter & Bed heads
- Oxygen Set
- CPX Suction Ring
- Brass Munsen Ring
- Degreased Medical Copper Tube
- Degreased Medical Gas Copper Fittings
- Medical Lockable Line Valve

MEDICAL GAS SOLUTIONS

# OXYGEN CONCENTRATORS

Smooth flowing systems

## VisionAire

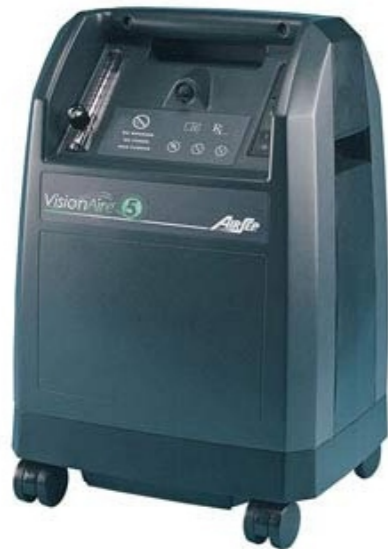

VisionAire

SPECIFICATIONS	
Oxygen Concentration:	1-5 liters per minute at 90% + 5.5/ -3% (Based on 70°F [21°C] at sea level)
Dimensions:	20.8 in. high, 14.1 in. wide, 11.5 in. deep (52.8 cm high, 35.8 cm wide, 29.2 cm deep)
Weight:	30 lb; shipping weight - 37 lb (13.6 kg; shipping weight - 16.7 kg)
Electrical:	115 VAC, 60 Hz, 3 amps, 290 watts 220-240 VAC, 50 Hz, 1.5 amps, 290 watts 230 VAC, 60 Hz, 1.5 amps, 290 watts
Sound Level:	40 dBA
Alarms:	Power Failure High and Low Pressure High Temperature Low Oxygen Concentration (with optional Oxygen Monitor)
Relative Humidity:	Up to 95% (non-condensing)

## FreeStyle

Portable Oxygen Concentrator



- ◆ Attractive, contemporary design
- ◆ Digital keypad/alarm display
- ◆ 1-5 Pulse settings
- ◆ Audible alarms and visual indicators
- ◆ Easy to use and operate
- ◆ Multiple power options
- ◆ Digital display for battery life Includes
- ◆ Airbelt with digital display
- ◆ Ultra-lightweight at 4.4 lbs (2.0 kg)
- ◆ Operates on AC/DC and rechargeable internal battery power
- ◆ Exceptional battery life
- ◆ FAA-approved for on-board, in-flight use
- ◆ Fashionable carrying case with adjustable shoulder strap
- ◆ Optional harness available to be worn as a backpack
- ◆ Up to 10 hours between battery recharges with the optional AirBelt at setting 1

**Weight:** 5.8 lbs

**Dimensions:** 10.5" H x 6.4" W x 4.4" D

**Power:** 100-250 VAC, 50/60 Hz; 11-16 VDC; rechargeable lithium battery

**Battery Duration:** up to 2 hours on internal battery & 7.5 hours when used with the AirBelt

## Focus

Portable Oxygen Concentrator



The AirSep Focus is a super light weight, portable oxygen concentrator offering a pulse dose setting of 2 to cover the most commonly prescribed setting. Early stage COPD oxygen users can enjoy active lifestyles with this small and durable device.

**Patients love the AirSep Focus because:**

- The AirSep Focus is small and light, weighing in at only 1.75 lbs. making it easy and discrete to carry.
- The AirSep Focus is quiet operation allowing you to not be distracted by a constant hum.
- The AirSep Focus operates with rechargeable batteries with a life up to 3 hours to maximize your time on the go.
- Works on AC power supply, and DC automotive power supply so you can take your portable oxygen concentrator anywhere and charge it.
- No user maintenance or intake filter to clean, giving you peace of mind.
- Simplest operation with one button to press and no flow to adjust, so it's really easy to use!



FAA Approved

## NewLife Intensity

**AirSep NewLife Intensity  
10 Liter Oxygen Concentrator**

- ◆ High pressure / high flow
- ◆ Pressure outlet 3 times higher than other concentrators
- ◆ Quiet operation
- ◆ Integral safety alarms
- ◆ Enables use of standard accessories
- ◆ Long tubing runs without drop-off in flow
- ◆ Performance: 2-9 LPM 92% ±3, 10 LPM 90% ±3
- ◆ Oxygen Outlet Pressure: 20 psig (138 kPa)
- ◆ Dimensions: 27.5" H x 16.5" W x 14.5" D
- ◆ Weight: 58 lbs
- ◆ Power: 120 VAC, 60 Hz
- ◆ Power consumption: 590 W



# MEDICAL GAS SOLUTIONS

Smooth flowing systems

## SureFlow



### SUREFLOW MULTI-PATIENT OXYGEN FLOW STATION

- ◆ Provides oxygen for up to 5 patients per unit, all from a single O<sub>2</sub> source
- ◆ For use with pediatrics to adults
- ◆ Can be connected with 2 or more units to accommodate more users
- ◆ Configured with 5 low flow flow meters
- ◆ Can be wall-mounted or placed on a tabletop/desktop
- ◆ Ideal for use with the New Life Intensity 10-series unit or any up-to-50 psig (345 kPa) O<sub>2</sub> source
- ◆ Can be customer-configured with any combination of flow meters

### Specifications

- ◆ Dimensions: 5.8" high x 9.7" wide x 7.2" deep (14.7 cm x 24.6 cm x 18.3 cm deep)
- ◆ Flow Rates: Low flow flowmeters can be used from 1/10 LPM to 1 LPM with 1 LPM increments with back lines for proper viewing angle.
- ◆ Flowmeter Accuracy: 0-1 LPM flowmeter ± 3% of full scale; 0-2 LPM flowmeter ± 5% of full scale
- ◆ Inlet Pressure: 7-50 psig (48-345 kPa)
- ◆ Operational temperature Range: 40° to 140°F (5° to 40°C). (Operating unit outside of this range can affect performance.)
- ◆ Storage Temperature Range: 30°F to 140°F (-1°C to 60°C)
- ◆ Weight: 3.8 lbs (1.7 kg)



## Pendants, Flowmeters & Bed Heads



Built from individually heat treated extruded aluminium sections, the unit provides separate compartments for medical gases and electrical services. Furthermore, the gas compartment is ventilated to prevent a buildup of gas inside the unit.

### Specific Benefits Include:

- Colour coded to customer requirements
- Extruded aluminium sections
- Separation of services as per BS EN 11197
- Integral up lighting and medial rails
- The main unit is normally supplied in white colour (RAL 9010).
- BS EN 9170 CPX Precision medical gas outlets as standard others available at request.
- Supplied pre-piped, pre-wired, fully tested and certified
- Medical Device Directive 93/42/EEC (CE0086).



### OXYGEN SET - GENTEC

OX-087	Oxygen Flowmeter	1	11,200.00	Gentec
OX-090	Oxygen Regulator	1	11,800.00	Gentec
OX-095	Oxygenhumidifier	1	3,800.00	Gentec

Oxygen regulator with 3/8" BSP outlet  
Single O<sub>2</sub> flowmeter and tubing nipple with 3/8" BSP connector  
Autoclavable Bubble Humidi

## CPX Sucton Regulator



- The compact design incorporates a clear 63mm Ø integral vacuum gauge is built inside the regulator body.
- Analog Display: ± 5% of Full Scale deflection.
- Metal back plate making the unit strong and reliable reducing repair costs.
- Accurate suction control within ranges 0 -300mmbar (LoSuck) and 0-760mmbar (HighSuck)
- Quick mode selector toggle switch for REG/OFF/FULL vacuum.
- The large control knob comes with three (3) easy-to-read settings making vacuum adjustments simple, even in emergency situations.
- Infection control easy to clean and wipe down
- Variety of inlet connections available BS, AFNOR, DIN and DISS
- Outlet connection 1/8" female NPT
- Safety trap recommended for use for protecting regulators and preventing accidental overflow, these connect directly to the unit 1/8" male NPT

## Brass Munsen Ring-m10



Munsen rings manufactured from brass with a single M10 tapping complete with brass screws. M10 to M6 reducing bush available on request. Suitable for suspending copper tube complying with BS EN 13348 & BS EN 1057 (formerly BS 2871) with metric threaded studding or screws.

### ORDERING INFORMATION

Size	Part Number	SSM
12mm	12MUN	100
15mm	15MUN	100
22mm	22MUN	100
28mm	28MUN	50
35mm	35MUN	40
42mm	42MUN	20
54mm	54MUN	20
76mm	76MUN	5
108mm	108MUN	1

SSM (Single Supply Multiple) is the minimum pack size products are available in. Pricing on products is always in relation to the SSM.

Other sizes are available on request.



# MEDICAL GAS SOLUTIONS

Smooth flowing systems

## EN 13348 DEGREASED MEDICAL COPPER TUBE



CPX copper tube is designed for use in Medical Gas Pipeline System (MGPS) installations and incorporates the specialist requirement of the MGPS industry to include cleanliness, packaging and usability required to attain the levels of quality as stated particularly in HTM 02-01.

### Specific Benefits Include:

- Each pipe is cleaned to have a maximum carbon level 0.20mg/dm<sup>2</sup>.
- Each pipe is individually end capped and bundled in sealed polythene bags to maintain cleanliness.
- Chemical composition CU.DHP to ISO 1190-1/CW024A to EN1412.
- All copper tube is manufactured under strict quality control procedures to ISO 9001: 2008 and CE marked under the Medical Device Directive 93/42/EEC (CE0086).
- Batch numbering for traceability is included on all pipework.
- Labelling on the copper tube will contain the following details: Date, Code of Manufacture, EN 13348, Tube Size, Manufacturer, Temper, British Standard Institute BSI Kitemarked, (CE0086).

### SIZE RANGE Other Diameter's & Lengths on request

Part no.	Diameter mm	Thickness mm	Length mtr	Tubes Per Bundle	Max Working pressure Bar
10CP	10	0.6	6	10	77
12CP	12	0.6	6	10	63
15CP	15	0.7	6	10	58
22CP	22	0.9	6	10	51
28CP	28	0.9	6	5	40
35CP	35	1.2	6	1	42
42CP	42	1.2	6	1	35
54CP	54	1.2	6	1	27
67CP	67	1.2	6	1	26
76CP	76	1.5	6	1	29
108CP	108	1.5	6	1	16



## DEGREASED MEDICAL GAS COPPER FITTINGS



Exclusively designed for Medical Gas Pipeline Systems (MGPS), CPX copper Fittings recognise and embrace the specialist requirements of the medical gas pipeline industry to include all aspects of design, cleanliness, packaging and usability required to be come a successful partner for installations of pipelines compliant with HTM 02-01, C11 and BS EN 7396.

- Each Fitting is individually bagged in clear protective polythene bags and sealed to maintain cleanliness.
- All Fittings carry a label identifying the degreased specification and production batch number.
- Cleanliness is guaranteed below 0.01 mg/cm<sup>2</sup> of hydrocarbons on the degreased surface of the Fitting.
- All boxes include logical and concise labeling identification.

## MEDICAL LOCKABLE LINE VALVE



The chrome plated valve handle is lockable in the open or closed position by way of a sliding device and brass padlock supplied to prevent unauthorized or inadvertent operation of the valve. For ease of installation all brass padlocks are the same size for the full range of ball valves from 15mm to 108mm.

All line valve assemblies are fully pressure tested and batch numbered for traceability prior to packing and delivery.

Lock able line valves are available for all standard pipe work sizes from ø15mm to ø108mm. Other size are available on request. Non-lockable versions are also available.

### ORDERING INFORMATION

Type	Part Number	O/Al Length mm
15mm	15LVN	380
22mm	22LVN	510
28mm	28LVN	530
35mm	35LVN	610
42mm	42LVN	630
54mm	54LVN	665
76mm	76LVN	970
108mm	108LVN	1070



# MEDICAL GAS SOLUTIONS

Smooth flowing systems

## MEDICAL GAS OUTLET

BRITISH STANDARD

**CPX PRECISION UK Ltd**  
Specialists in HTM02-01 Medical Gas Pipeline Equipment



Terminal units are available for oxygen, nitrous oxide, 50% oxygen /50% nitrous oxide mixture, medical air, surgical air, medical vacuum and AGSS. Mounting options include surface, lush, bedhead and pendant. Test plugs are included with lush, surface and bedhead types for first ix pressure testing on site.

### Designed to meet the requirements of

- HTM 02-01 Medical Gas Pipeline Systems.
- BS EN 7396-1 Pipelines for Compressed Medical Gases and Vacuum.
- BS EN 7396-2 Anaesthetic Gas Scavenging Disposal Systems.
- BS EN 9170-1 Terminal Units for use with Compressed Medical Gases and Vacuum.
- BS EN 9170-2 Terminal Units for Anaesthetic Gas Scavenging Systems.
- C11 NHS Model Engineering Specification Medical Gases.
- BS 5682 Specification for Probes (quick connectors) for Medical Gases.
- BS 6834 Active Anaesthetic Gas Scavenging Systems.
- Medical Device Directive 93/42/EEC (0086) CE.
- BS EN 15908 Non-interchangeable Screw Threaded (NIST) Low-pressure Connectors for Medical Gases.

## Gas Manifolds

### Automatic Medical Gas Manifold.

**CPX PRECISION UK Ltd**  
Specialists in HTM02-01 Medical Gas Pipeline Equipment

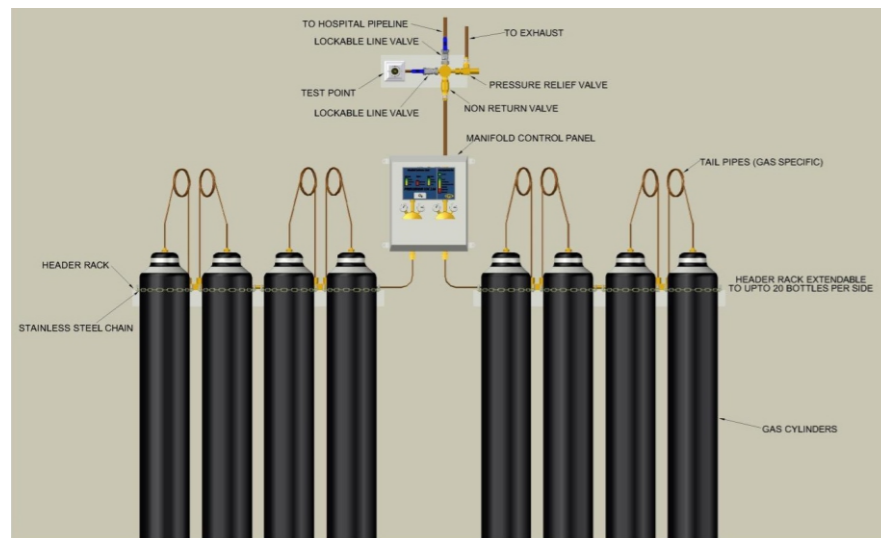

The CPX automatic manifold provides a continuous supply of gas from two banks of cylinders to the medical gas pipeline system by changing from the duty bank to the standby bank automatically when the duty bank has become depleted. The CPX automatic medical gas manifold plant is supplied as a packaged product ready for immediate installation, tested and prepared at the factory for the specific gas indicated.



AMBULANCE SETUP



### AMBULANCE SETUP

- Ambulance Accessories
- Vehicle Conversion
- Standard Equipment
- Optional Equipment

# AMBULANCE SETUP

On the go equipments



## Basic Life Support Equipments.

Ventilation and airway equipment, heart monitoring and defibrillation, immobilization devices, bandages, communication devices, obstetrical kits, miscellaneous medical equipment such as a sphygmomanometer with pediatric, adult, and plus-sized cuffs, a stethoscope, height and weight measuring devices, thermometers, cold packs, blankets, transport chairs, and lubricant are required.

Non-latex infection control like nitrile gloves, facemasks, gowns, and disinfectant solution for equipment are required.

Injury prevention equipment inside an ambulance should include seatbelts, a fire extinguisher, and traffic signaling devices.

## The Advanced Life Equipments

Support list includes all the above items and several more, including advanced airway and ventilation equipment, vascular access equipment, pre-loaded medications for cardiac conditions, allergies, epilepsy, and pain-killers. It can include other and more extensive drugs and equipment depending on individual medical director recommendation.

## Optional equipment

- Defibrillator
- Ventilator
- Pulse Oximeter
- Syringe Pump and Infusion Pump
- Long Backboard, Scoop Stretcher, Chair Stretcher and Pole Stretcher
- Central Suction system with Vacuum Outlet and One Liter Jar
- AC/DC Power Supply with 12V into 220V
- Inverter and 220V Outlet
- Battery Charger and Inlet Installed on the Body with Connecting Cable



### Fordable Stretcher

This stretcher with outrigger can be folded in length and width, easy for transportation and storage. The orange fabric is fire proof, water proof, anti-cackling and easy to clean. It is characterized by its being light weight, portable, reliable quality, easy to carry out and safe to use, etc. It is mainly used for the hospitals, emergency centers and battle field carry for patients and wounded person.



### Stair Stretcher

- The sturdy aluminum frame is strong enough to hold up to 400 pounds.
- Three adjustable straps with quick-release buckles ensure the patient's comfort and safety.
- Non-slip grips on the rear and front handles help rescuers maneuver the Aluminum Stair Chair easily.
- Compact folding allows you to stow the stair chair in the ambulance without taking up a lot of space.
- Chair is designed to help EMTs-Paramedics transport patients through tight spaces and up or down stairs.

Anti-Cracking



### Ambulance Stretcher (Automatic Loading)

Made from high-strength aluminum alloy. The foam cushion and the adjustable back, allow the maximum comfort. It is easy to operate, one person can operate and send the patient (with this stretcher) to the ambulance vehicle. The mechanical foldaway legs are controlled by the handles on one end of the stretcher.

Also the stretcher can be **locked by the security devices** on the ambulance vehicle. This type of stretcher can be **characterized as light weight, durable, safe and easy to operate.**



### CS1-Chair Stretcher

This Foldable stretcher is made of high strength aluminum alloy material and fluid resistant PVC stretcher surface; It can be converted to a chair, be stored in limited spaces, and has two wheels engineered for easy operation

# AMBULANCE SETUP

On the go equipments



## Basket Stretcher

Designed to rescue injured persons from locations where lengthy foot travel is mandatory. The stretcher breaks into two halves which can be back-packed to the point of rescue and assembled in seconds. Positive - locking quick-release pins secure two halves together. Four straps are standard.



## Long Spinal Board

Made of PIE material with no discharge contaminator, and firmness to wear. The structure is allowed X-rays because of its completely translucent. It is mainly used for hospitals, sports, ambulance and outdoors to carry patients and wounded person.

## Scoop Stretcher

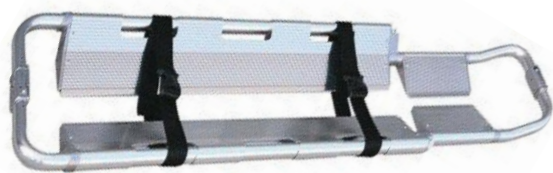

The Scoop stretcher is primarily used to transfer fractured and seriously wounded patients. At both ends of the scoop stretcher, a hinged and joined mechanism is set in the middle, which can set the scoop stretcher into two parts. Our design allows for easy locking and unlocking which is ideal for emergency situations.



On the go Equipment



## Cervical Collar

- Loop contact closures for easier use
- Adjustable size designed for using on a wide range of patients
- The foam cervical collar is used for cervical injuries requiring non-rigid support and limited mobility
- May also be used as an aid for the relief of pain associated with neck muscle spasms or whiplash injuries



## HM1-Head Immobilizer

Design of this head immobilizer make it compatible with all EMSS aluminum alloy stretchers and plastic spine boards



## Ed1-Extrication Device

For uses of extrication and spinal immobilization vertically rigid and horizontally flexible



## VM1- Vacuum Mattes

The removable strapping and handle system reduces the areas that could trap fluids. One valve evacuates the entire unit. Lightweight, durable immobilization system designed to fold down to a compact size for storage and sets up quickly for immediate use.



## VS1- Vacuum Splint

Vacuum splints provide the best possible support and versatile extremity splinting system. The design is ideal for dislocated shoulders, suspected fracture of arms, legs, and joints, or infant immobilization. They suite a wide variety of emergency applications.

## First-aid medical kit

1. 1 pc Hand Suction Pump
2. 1 pc Resuscitator Bag
3. 1 pc E-Mask
4. 2 pcs Guedel Airway
5. 1 pc Clinical Thermometer
5. 1 pc Mouth Opener
7. 2 pcs Disposable Syringe
8. 1 pc Tongue Forceps
9. 1 pc Sterile Scalpel
10. 2 pcs Lancet
11. 5 pcs Wooden Tongue Depressor
12. 1 pair Surgical Scissors
13. 1 pair Dressing Tweezers
14. 10 pcs Safety Pins
15. 2 pairs Sterile Latex Gloves
16. 1 pc Sphygmomanometer
17. 1 pc Stethoscope
18. 1 pc Boston
19. 1 pc Tourniquet
21. 30 pcs Alcohol Prep Pad



# AMBULANCE SETUP

On the go equipments

## Conversion of Vehicle:



- Sub-structure, Insulation, Flooring, Isolation, Reinforcement and **Covering of Patient's Cabin.**
- Advanced Electrical and Electronic Systems with Integrated Control Panel.
- Air Conditioning **System for both Driver's and Patient's Cabin**
- Roof-type Ventilation Fan
- Ceiling Shelf with Interior Lights
- Complete Equipment Cabinet made of Stainless Steel Frame and Stands
- Modular Equipment Paneling
- Bulk Head with Sliding Window
- Seat tip-up neck with under seat storage area and side back rest and seat belts
- **Technician's Seat**
- **General and complete various lighting of patient's cabin**
- Piping and Tubing of Oxygen System
- Livery , Window-tinting, Designing and Painting of Ambulance Body
- Alarm, Public Address, Flashing Roof Beacon Light, LED Lightbar and Siren
- Fire Extinguisher
- Platform for Stretcher Installation
- Waste Container



Converted for quick medical assistance 



## STERILIZATION

- Steam Sterilizers
- Sterilization Pouches
- Automatic Autoclaves
- Manual Autoclaves
- Accessories

STERILIZATION

# Autoclave & Sterilization Equipment

## All American Electric Steam Sterilizers



All American Electric Steam Sterilizers, models 25X, 50X & 75X. These units are available in either 120 or 240 volts. One of the most important things to note is that the 25X Electric Steam Sterilizer uses a 1050 watt heating element while the other units (The 50X and 75X) each have a 1650 watt heating element.

The Model 50X and 75X uses a 1650 watt heating element. This increased wattage and heating capacity means that the units will get up to operational temperature far quicker than the 25X. Plus, the 50X & 75X have all new electrical controls as well as a new thermostat which is designed to hold a much tighter operating band.

Therefore there will be less variation as the thermostat turns the heating element on and off to maintain a certain level of heat. All American steam sterilizers are used world-wide to sterilize a wider range of materials. Temperature, pressure and time are the main factors in this process.

All American Sterilizers make it possible for doctors, dentists, first aid stations, hospitals, laboratories and of course, mycologist to have dependable sterilization facilities in a portable unit at an extremely low cost.

- Features:**
- Portable, Economical, Reliable Operation
  - Metal to Metal Seal
  - The metal to metal seal eliminates all rubber gaskets.
  - Pressure Gauge Accuracy
  - Pressure Relief Valve
  - UL Approved
  - Heavy cast aluminum cover and bottom construction
  - Aluminum inner container with rack
  - Flexible metal exhaust tube
  - Dial gauge and control valve
  - Metal-to-metal seal (no rubber gasket)
  - Large sterilizing capacity
  - Complete, effective sterilization at the lowest possible cost
  - Individual corrugated carton packaging



**Stainless Steel Cooker Type (Seamless) - Autoclave**



**Sterilizer Pressure Cooker 16 Litres**



**Aluminum Pressure Cooker Type 19 Litres**

# Fully Automatic Autoclaves

## EA / EKA - Fully Automatic Autoclaves



7.5 Liter Chamber Models

19/23 Liter Chamber Models

All printers are optional

### Closed Door Active Drying Air Pump:

With extra fast and efficient drying cycles, the EKA and EA autoclaves significantly increase your productivity. These two models have the added benefit of a high efficiency air pump which allows closed door active drying. The EKA and EA are built for improved sterilization with the ability to dry packs and pouches.

### Benefits:

- More thorough drying and sterilization
- Faster drying for a shorter overall cycle
- 0.2 µm HEPA air filter provides sterile, bacteria-free air for drying

Model	Chamber Volume	Cold Cycle Time	Hot Cycle Time
<b>EA Series</b>			
2340EA	19 Liter	23 min.	16 min.
2540EA	23 Liter	25 min.	18 min.
3850EA	64 Liter	31 min.	20 min.
3870EA	85 Liter	31 min.	20 min.
<b>EKA Series</b>			
2340EKA	19 Liter	14 min.	11 min.
2540EKA	23 Liter	14 min.	11 min.

-Tested for unwrapped instruments. Cycle times includes heatup, sterilization exposure and exhaust. All cycle times may vary with instrument load and voltage.

## Autoclaves



50 Litres



100 Litres



120 Litres

# Manual Autoclave Series

## Chamber Models

64/85 Liter Chamber Models



34 Liter Chamber Models



7.5 Liter Chamber Models

19/23 Liter Chamber Models

Complies with strict international directives and standards:

PED 97/23 • MDD 93/42 • ASME • UL/EN 61010-1 • FDA • ISO 13485:2003 • ISO 9001:2008



Model	Chamber Volume	Cold Cycle Time	Hot Cycle Time
<b>M Series</b>			
2340M	19 Liter	20 min.	12 min.
2540M	23 Liter	22 min.	14 min.
3140M	34 Liter	25 min.	17 min.
3850M	64 Liter	29 min.	17 min.
3870M	85 Liter	31 min.	20 min.
<b>MK Series</b>			
1730MK (Valueklave)	7.5 Liter	12 min.	9 min.
2340MK	19 Liter	12 min.	9 min.
2540MK	23 Liter	12 min.	9 min.

Tested for unwrapped instruments. Cycle times includes heatup, sterilization exposure and exhaust . All cycle times may vary with instrument load and voltage.



## 2540MKA

### The First Manual Autoclave with Closed Door Drying

The 2540MKA, features heating auto-shuto ffat completion of sterilization cycle, saving energy and increasing your safety and productivity. Before leaving the clinic, set the 2540MKA to night mode, start a cycle and the instruments will be sterile and ready to use on return.

- Closed door active drying air pump
- Single action sterilization cycle
- Overheat safety protection
- Automatic night mode shuto ffis a time and energy saver

Model	2540MKA
Chamber Dimensions øxL (mm)	254 x 476
Chamber Volume	23 Liter
Cold Cycle Time	16 min.
Hot Cycle Time	12 min.

Cycle time may vary with instrument load and voltage



- 1 Cycle Status Indicator
- 2 Pressure Gauge
- 3 Power Switch
- 4 Sterilization Timer
- 5 Water Pump Switch
- 6 Drying and Sterilization Timer
- 7 Temperature Selector
- 8 Night Mode Switch

## Accessories

### Impulse Sealing Machines

Sterilization is effective only if the sterility of the instruments is preserved from the point of sterilization until they are used. The sealing process ensures that the instruments remain sealed after sterilization and maintain perfect sterility during their Automatic night mode shuto ffis a time and energy saver shelf-life. Our range of fast and reliable impulse sealers complies with the strictest quality and safety standards (DIN 58953-7). For rapid instrument turnaround we offer an automated range of rotary sealing machines.



### Water Distiller

Use mineral-free water to protect your autoclave and instruments.

- Increases the life of the autoclave piping system
- Distilled water at the fraction of the cost of bottled distilled water



### Chamber Brite™

Chamber Brite™ effectively cleans and descales the chamber, the reservoir and copper tubing of any steam autoclave.



# Autoclave & Sterilization Equipment

## Cleaning, Disinfection & Sterilization

### More from Tuttnauer:

Featuring Tuttnauer's range of cleaning, disinfection and sterilization solutions



Large sterilizers for various industries and market needs



Washers/disinfectors for hospitals and laboratories



Laboratory autoclaves ranging in size and application



Pre & post vacuum tabletop sterilizers designed to perform class B cycles

### STERILIZATION POUCHES

#### TOPSTERI Heat Sealing Flat Sterilization Reels and Pouches



**SIZES AVAILABLE:**  
● 135mmx255mm (5-1/3"x10")  
● 90mmx230mm (3-1/2"x9")



**SIZES AVAILABLE:**  
● 100mmx200mts (4")

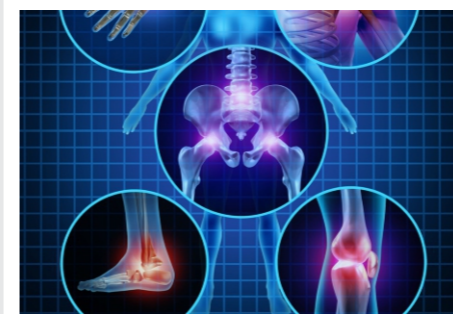

### ORTHOPAEDIC

- DHS & DCS
- Trauma Plates
- Interlocking Intramedullary Nails
- Orthopedic Instruments
- Locking Compression Plates Systems
- Screws

ORTHOPAEDIC IMPLANTS



# Orthopaedic Implants

## Instrument Sets

### Orthopaedic Instrument & Implant Sets

Small Fragment Plates (ao Type)

Large Fragment Plates (ao Type)

Hip Screw (DHS/DCS)

Dynamic Hip Locking Plates

Large Fragment Plates (LCP)

Mini Fragment Plates

Cannulated Compression Screw System

Cannulated Cancellous Screw (HB7.3)

Reconstruction Femoral Interlocking Nail

Tibial Interlocking Nail

Retrograde Femoral Interlocking Nail

Expandable Interlocking Nail

Instrument Set for Bridge-Link Combined Fixation

Retrograde Femoral Interlocking Nail

Instrument Set for Bridge-Link Combined Fixation

Instrument Set for Bridge-Link Combined Fixation



### Bone Screws



<b>Cortical Screw</b> (Half & Full threaded)	2.7mm, 3.5mm, 4.5mm,
<b>Cancellous Screw</b> (Half & Full threaded)	3.5mm, 4.0mm, 4.5mm, 6.5mm,
<b>Cannulated Cancellous Screw</b>	3.5mm, 4.5mm, 7.3mm,
<b>Countersink Cannulated Cancellous Screw</b>	
<b>Self-tapping locking Screw</b>	3.5mm, 5.0mm,
<b>Screw Hole Insert</b>	3.5mm, 5.0mm,

# Trauma Plates

## General Plates Systems

### Clavicle



**Clavicle Hook Plate (I)**

**Application:** Fractures of clavicle.  
**Width:** 10mm  
**Thickness:** 3mm



**Clavicle Hook Plate (II)**

**Application:** Fractures of clavicle.  
**Width:** 17mm  
**Thickness:** 3mm



**Reconstruction Clavicle Hook Plate**

**Application:** Fractures of clavicle.  
**Width:** 9mm  
**Thickness:** 2.5mm



**Reconstruction Clavicle Plate (I)**

**Application:** Fractures of clavicle.  
**Width:** 10mm  
**Thickness:** 2.5mm



**Reconstruction Clavicle Plate (II) -Proximal**

**Application:** Fractures of clavicle.  
**Width:** 10mm  
**Thickness:** 2.5mm



**Reconstruction Clavicle Plate (II) -Distal**

**Application:** Fractures of clavicle.  
**Width:** 10mm  
**Thickness:** 2.5mm



**Reconstruction Clavicle Plate (II) -Medial**

**Application:** Fractures of clavicle.  
**Width:** 10mm  
**Thickness:** 2.5mm

### Humerus



**LC-DCP Plate (Humerus)**

**Application:** For fractures of the humerus.  
**Width:** 12mm  
**Thickness:** 3mm



**Proximal Lateral Humeral Plate**

**Application:** Fractures of proximal lateral humerus.  
**Width:** 12.5mm  
**Thickness:** 2.5mm



**Reconstruction Distal Humeral Plate (Y-shape)**

**Application:** Fractures of distal humerus.  
**Width:** 12.5mm  
**Thickness:** 2.5mm



**Distal Medial Humeral Plate**

**Application:** Fractures of medium distal humerus.  
**Width:** 12mm  
**Thickness:** 2mm



**Distal Lateral Humeral Plate**

**Application:** Fractures of medium distal humerus  
**Width:** 12mm  
**Thickness:** 2mm



**Distal Lateral Humeral Plate**

**Application:** Fractures of medium distal humerus  
**Width:** 12mm  
**Thickness:** 2mm



**Dynamic Compression Plate (Humerus)**

**Application:** For fractures of the humerus  
**Width:** 12mm  
**Thickness:** 3mm

# Trauma Plates

## General Plates Systems

### Ulna & Radius



**Reconstruction Plate**  
**Application:** For fractures of the ulna, radius, fibula.  
**Width:** 10mm  
**Thickness:** 2.5mm



**One-third Tubular Bone Plate**  
**Application:** For fractures of the ulna, radius, fibula.  
**Width:** 9.5mm  
**Thickness:** 1.2mm



**Olecranon Hook Plate**  
**Application:** Fractures of proximal ulna and olecranon.  
**Width:** 10mm  
**Thickness:** 2mm



**Volar Distal Radius Plate (Small)**  
**Application:** Fractures of the distal radius (applied to the volar aspect).  
**Width:** 10mm  
**Thickness:** 1.5mm



**Dorsal Distal Radius Plate (Oblique)**  
**Application:** Fractures of the distal radius (applied to the dorsal aspect).  
**Width:** 10mm  
**Thickness:** 1.5mm



**Dynamic Compression Plate (Ulna, Radius)**  
**Application:** For fractures of the ulna, radius.  
**Width:** 10mm  
**Thickness:** 3mm



**LC-DCP Plate (Ulna, Radius)**  
**Application:** For fractures of the ulna, radius.  
**Width:** 10mm  
**Thickness:** 3mm

### Femur



**Dynamic Compression Plate (Femur)**  
**Application:** For fractures of the Femur  
**Width:** 18mm  
**Thickness:** 5mm



**LC-DCP Plate (Femur)**  
**Application:** For fractures of the femorus.  
**Width:** 18mm  
**Thickness:** 5mm



**Proximal Lateral Femoral Plate**  
**Application:** Application: Fractures of lateral proximal femur.  
**Width:** 17mm  
**Thickness:** 5mm



**Proximal Lateral Femoral Plate**  
**Application:** Application: Fractures of lateral proximal femur.  
**Width:** 17mm  
**Thickness:** 5mm



**Distal Femoral Condylar Buttress Plate**  
**Application:** Used to support the femur in case where the fracture site is comminuted.fracture  
**Width:** 18mm **Thickness:** 5mm

# Trauma Plates

## General Plates Systems

### Tibia & Fibula



**Dynamic Compression Plate (Tibia)**  
**Application:** For fractures of the tibia  
**Width:** 14mm  
**Thickness:** 4mm



**LC-DCP Plate (Tibia)**  
**Application:** For fractures of the tibia.  
**Width:** 14mm  
**Thickness:** 4mm



**Buttress Plate (T-shape)**  
**Application:** Fractures of medial proximal tibia plateau.  
**Width:** 16mm  
**Thickness:** 2.5mm



**Buttress Plate (T-shape)**  
**Application:** Fractures of medial proximal tibia plateau.  
**Width:** 16mm  
**Thickness:** 2.5mm



**Buttress Plate (L-shape)**  
**Application:** Fractures of lateral proximal tibia plateau.  
**Width:** 16mm  
**Thickness:** 2.5mm



**Proximal Medial Tibial Plate (Golf -shape)**  
**Application:** Fractures of medial proximal tibia.  
**Width:** 16mm  
**Thickness:** 4mm



**Proximal Medial Tibia I Plate (Golf -shape)**  
**Application:** Fractures of medial proximal tibia.  
**Width:** 16mm  
**Thickness:** 4mm



**Proximal Lateral Tibial Plate (Golf -shape)**  
**Application:** Fractures of lateral proximal tibia.  
**Width:** 16mm  
**Thickness:** 4mm



**Proximal Lateral Tibial Plate (Golf -shape)**  
**Application:** Fractures of lateral proximal tibia.  
**Width:** 16mm  
**Thickness:** 4mm



**Distal Medial Tibial Plate**  
**Application:** Fractures of medial distal tibia.  
**Width:** 16mm  
**Thickness:** 3mm



**Distal Medial Tibial Plate**  
**Application:** Fractures of medial distal tibia.  
**Width:** 16mm  
**Thickness:** 3mm



**Distal Lateral Tibial Plate**  
**Application:** Fractures of distal lateral tibia.  
**Width:** 16mm  
**Thickness:** 3mm



**Distal Lateral Fibular Plate**  
**Application:** Distal fibular fracture  
**Width:** 9mm  
**Thickness:** 2.5mm



**Reconstruction Plate**  
**Application:** For fractures of the ulna, radius, fibula.  
**Width:** 10mm  
**Thickness:** 2.5mm



**One-third Tubular Bone Plate**  
**Application:** For fractures of the ulna, radius, fibula.  
**Width:** 9.5mm  
**Thickness:** 1.2mm

# Trauma Plates

## General Plates Systems

### Pelvis



**Reconstruction Plate (Curved)**  
**Application:** Fractures of pelvic.  
**Width:** 10mm  
**Thickness:** 2.5mm



**Reconstruction Distal Humeral Locking Plates (Y-shape)**  
**Application:** Fractures of distal humerus.  
**Spec.:** 80mm\*3holes-185mm\*10holes  
**Material:** Titanium  
**Matching Screw**  
 Φ3.5 Locking Screw;  
 Φ3.5 Cortical Screw



**Distal Lateral Humeral locking Plate (I), Combined-lock**  
**Application:**  
 Fractures of lateral distal humerus  
**Spec.:** 67mm\*3holes-139mm\*11holes  
**Material:** Titanium  
**Matching Screw**  
 3.5 Cortical Screw  
 2.7/3.5 Locking Screw  
 4.0 Cancellous Screw

### Calcaneus



**Calcaneus Locking Plates(I)**  
**Application:** Calcaneus Fractures  
**Spec.:** 11holes-15holes  
**Material:** Titanium  
**Matching Screw:** Φ3.5 Locking Screw;  
 Φ3.5 Cancellous Screw



**Calcaneus Locking Plates(II)**  
**Application:** Calcaneus Fractures  
**Spec.:** 14holes  
**Material:** Titanium  
**Matching Screw:** Φ3.5 Locking Screw;  
 Φ3.5 Cancellous Screw



**Calcaneal Locking Plate (VI)**  
**Application:** Calcaneus Fractures  
**Thickness:** 2mm



**Calcaneus Locking Plates(V)**  
**Application:** Calcaneus Fractures  
**Spec.:** 8holes  
**Material:** Titanium  
**Matching Screw:** Φ3.5 Locking Screw;  
 Φ3.5 Cancellous Screw



**Calcaneus Locking Plates(III)**  
**Application:** Calcaneus Fractures  
**Spec.:** 13holes  
**Material:** Titanium  
**Matching Screw:** Φ3.5 Locking Screw;  
 Φ3.5 Cancellous Screw



# DHS & DCS

## Dynamic Hip and Condylar Screw System

### DHS DCS Systems

<b>Dynamic Hip Locking Plate</b>	120mm,138mm,156mm,174mm,192mm,210mm
<b>DCS Plate (95)</b>	146mm,162mm,178mm,194mm,210mm,226mm
<b>DHS Plate (135)</b>	94mm,162mm,178mm,194mm,210mm,226mm
<b>DHS/DCS Lag Screw</b>	12mm DIA
<b>Femoral Self-Locking Screw</b>	6.0mm



# Interlocking Intramedullary Nails

## Trauma\_Interlocking Nail Systems



**Proximal Femoral Nail Anti-rotation (PFNA)**

**Application:** Used in a variety of proximal fractures, such as: 1. Sub-trochanteric Fractures; 2. Inter-trochanteric Fractures.



**PFNA Locking Bolt**



**PFNA Blade**



**Femoral Interlocking Nail**

**Application:** Used for fractures situated in the region extending from just below the intact lesser trochanter to just above the supra-condylar region.

**Matching Locking Bolt**

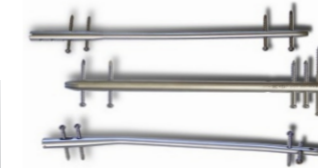

**Retrograde Femoral Interlocking Nail**

**Application:** Used for femoral shaft fractures.



**Matching Lag Screw**



**Reconstruction Femoral Interlocking Nail (Standard Gamma Nail)**

**Application:** Used in a variety of proximal fractures, such as: 1. Sub-trochanteric Fractures; 2. Inter-trochanteric Fractures; 3. Nonunions.

# Interlocking Intramedullary Nails

## Trauma\_Interlocking Nail Systems



**Reconstruction Femoral Interlocking Nail (Long Gamma Nail); (Left)**

**Application:** Used in a variety of proximal fractures, such as: 1. Sub-trochanteric Fractures; 2. Inter-trochanteric Fractures; 3. Nonunions. 4. Femoral shaft fractures.

**Reconstruction Femoral Interlocking Nail (Long Gamma Nail); (Right)**

**Application:** Used in a variety of proximal fractures, such as: 1. Sub-trochanteric Fractures; 2. Inter-trochanteric Fractures; 3. Nonunions. 4. Femoral shaft fractures.



**Matching Lag Screw**



**Tibial Interlocking Nail**

**Application:** Used for all fractures extending from 3cm distal to the tibial sub-trochanteric, to within 6cm of the distal articular surface, provided that the epiphyses are closed

**Matching Screw**

# Locking Compression Plates System

## Trauma\_LCP Systems (Titanium)



**LC-LCP System**

**Application:** For fractures of ulna, radius, humerus, tibia, femur.  
**Spec.:** 85mm\*5holes-160mm\*10holes (Ulna, Radius)  
 106mm\*6holes-202mm\*12holes (Humerus)  
 123mm\*6holes-231mm\*12holes (Tibia)  
 127mm\*6holes-271mm\*14holes (Femur)  
**Material:** Titanium  
**Matching Screw:**  $\Phi$ 3.5 Locking Screw;  
 $\Phi$ 3.5 Cortical Screw (Ulna, Radius, humerus)  
 $\Phi$ 5.0 Locking screw;  
 $\Phi$ 4.5 Cortical Screw (Tibia, Femur)



**Reconstruction Locking Plates**

**Application:** For fractures of ulna, radius, fibula.  
**Spec.:** 48mm\*4holes-144mm\*12holes  
**Material:** Titanium  
**Matching Screw:**  $\Phi$ 3.5 Locking Screw;  
 $\Phi$ 3.5 Cortical Screw



**Clavicle Diaphysis Locking Plates**  
**Application:** Fractures of clavicle.  
**Spec.:** 58mm\*5holes-135mm\*12holes  
**Material:** Titanium  
**Matching Screw:**  $\Phi$ 3.5 Locking Screw;  
 $\Phi$ 3.5 Cortical Screw;



**Clavicle Hook Reconstruction Locking Plates**  
**Application:** Fractures of clavicle  
**Spec.:** 51mm\*2holes-95mm\*6holes  
**Material:** Titanium  
**Matching Screw:**  $\Phi$ 3.5 Locking Screw;  
 $\Phi$ 3.5 Cortical Screw;



**Limited Contact Humeral Metaphysis Plates**  
**Application:** Humeral metaphyseal fractures.  
**Spec.:** 86mm\*6holes-190mm\*14holes  
**Material:** Titanium  
**Matching Screw:**  $\Phi$ 3.5 Locking Screw;  
 $\Phi$ 3.5 Cortical Screw;  
 $\Phi$ 3.5 Cancellous Screw



**Proximal Humeral locking Plates (II)**  
**Application:** Fractures of lateral proximal humerus.  
**Spec.:** 74mm\*3holes-158mm\*10holes  
**Material:** Titanium  
**Matching Screw:**  $\Phi$ 3.5 Locking Screw;  
 $\Phi$ 3.5 Cortical Screw



**Distal Medial Humeral locking Plate, Combined-lock**  
**Application:** Fractures of medial distal humerus  
**Spec.:** 68mm\*3holes-140mm\*11holes  
**Material:** Titanium  
**Matching Screw:** 3.5 Cortical Screw  
 2.7/3.5 Locking Screw  
 4.0 Cancellous Screw



**Cloverleaf Plate**  
**Application:** Fractures in proximal humerus and distal tibia  
**Spec.:** 88mm\*3holes-136mm\*6holes  
**Material:** Titanium  
**Matching Screw:** 3.5 Cortical Screw  
 Locking Screw  
 3.5/4.0 Cancellous Screw



**Olecranon Hook Locking Plates**  
**Application:** Fractures of distal humerus.  
**Spec.:** 71mm\*3holes-155mm\*10holes  
**Material:** Titanium  
**Matching Screw:**  $\Phi$ 3.5 Locking Screw;  
 $\Phi$ 3.5 Cortical Screw



**Volar Distal Radius Locking Plates (Anatomic)**  
**Application:** Fractures of the distal radius (applied to the volar aspect).  
**Spec.:** 50mm\*3holes-105mm\*8holes  
**Material:** Titanium  
**Matching Screw:**  $\Phi$ 3.5 Cortical Screw  
 $\Phi$ 3.5 Locking Screw  
 $\Phi$ 3.5/4.0 Cancellous Screw



**Volar Distal Radius Locking Plates (Small), Combined-lock**  
**Application:** Fractures of the distal radius (applied to the volar aspect).  
**Spec.:** 50mm\*3holes-114mm\*8holes  
**Material:** Titanium  
**Matching Screw:**  $\Phi$ 3.5 Cortical Screw  
 $\Phi$ 3.5 Locking Screw  
 $\Phi$ 3.5/4.0 Cancellous Screw



**Proximal Humeral Locking Plates (III)**  
**Application:** Fractures of proximal humerus.  
**Spec.:** 107mm\*3holes-191mm\*9holes  
**Material:** Titanium  
**Matching Screw:**  $\Phi$ 3.5 Locking Screw;  
 $\Phi$ 3.5 Cortical Screw



**Distal Lateral Humeral locking Plate, Combined-lock**  
**Application:** Fractures of lateral distal humerus  
**Spec.:** 67mm\*3holes-139mm\*11holes  
**Material:** Titanium  
**Matching Screw:** 3.5 Cortical Screw  
 2.7/3.5 Locking Screw  
 4.0 Cancellous Screw



**Volar Distal Radius Locking Plates (Small), Combined-lock**  
**Application:** Fractures of the distal radius (applied to the volar aspect).  
**Spec.:** 50mm\*3holes-114mm\*8holes  
**Material:** Titanium  
**Matching Screw:**  $\Phi$ 3.5 Cortical Screw  
 $\Phi$ 3.5 Locking Screw  
 $\Phi$ 3.5/4.0 Cancellous Screw



**Dorsal Distal Radius Locking Plates (Small)**  
**Application:** Fractures of distal radius (applied to the dorsal aspect).  
**Spec.:** 56mm\*3holes-116mm\*8holes  
**Material:** Titanium  
**Matching Screw:**  $\Phi$ 3.5 Locking Screw;  
 $\Phi$ 3.5 Cortical Screw



**Proximal Lateral Femoral Locking Plates**  
**Application:** Fractures of lateral proximal femur.  
**Spec.:** 111mm\*3holes-303mm\*15holes  
**Material:** Titanium  
**Matching Screw:**  $\Phi$ 5.0 Locking Screw  
 $\Phi$ 4.5 Cortical Screw



**Reconstruction Locking Plates (Curved)**  
**Application:** Fractures of pelvis.  
**Spec.:** 48mm\*4holes-147mm\*14holes  
**Material:** Titanium  
**Matching Screw:**  $\Phi$ 3.5 Locking Screw  
 $\Phi$ 3.5 Cancellous Screw

# Locking Compression Plates System

Trauma\_LCP Systems (Titanium)



### Distal Lateral Femoral Locking Plates

**Application:** Used to support the femur in case where the fracture site is comminuted.  
**Spec.:** 116mm\*3holes-316mm\*13holes  
**Material:** Titanium  
**Matching Screw:**  $\Phi$ 5.0 Locking Screw  
 $\Phi$ 4.5 Cortical Screw

### Distal Femoral Condylar Buttress Locking Plates

**Application:** Used to support the distal femur in case where the fracture site is comminuted.  
**Spec.:** 98mm\*3holes-258mm\*13holes  
**Material:** Titanium  
**Matching Screw:**  $\Phi$ 5.0 Locking Screw  
 $\Phi$ 4.5 Cortical Screw

### Buttress Locking Plates (L-shape)

**Application:** Fractures of lateral proximal tibia.  
**Spec.:** 68mm\*3holes-180mm\*10holes  
**Material:** Titanium  
**Matching Screw:**  $\Phi$ 5.0 Locking Screw;  
 $\Phi$ 4.5 Cortical Screw



### Buttress Locking Plates (T-shape)

**Application:** Fractures of medial proximal tibia plateau.  
**Spec.:** 68mm\*3holes-180mm\*10holes  
**Material:** Titanium  
**Matching Screw:**  $\Phi$ 5.0 Locking Screw;  
 $\Phi$ 4.5 Cortical Screw

### Proximal Lateral Tibial Locking Plates (Golf-shape)

**Application:** Fractures of lateral proximal tibia.  
**Spec.:** 97mm\*3holes-289mm\*15holes  
**Material:** Titanium  
**Matching Screw:**  $\Phi$ 5.0 Locking Screw;  
 $\Phi$ 4.5 Cortical Screw

### Proximal Medial Tibial Locking Plates (Golf-shape)

**Application:** Fractures of medial proximal tibia.  
**Spec.:** 89mm\*3holes-281mm\*15holes  
**Material:** Titanium  
**Matching Screw:**  $\Phi$ 5.0 Locking Screw;  
 $\Phi$ 4.5 Cortical Screw



### Distal Lateral Tibial Locking Plates (II)

**Application:** Fractures of lateral distal tibia.  
**Spec.:** 86mm\*3holes-246mm\*13holes  
**Material:** Titanium  
**Matching Screw:**  $\Phi$ 5.0 Locking Screw;  
 $\Phi$ 4.5 Cortical Screw

### Distal Medial Tibial Locking Plates

**Application:** Fractures of medial distal tibia.  
**Spec.:** 86mm\*3holes-246mm\*13holes  
**Material:** Titanium  
**Matching Screw:**  $\Phi$ 5.0 Locking Screw;  
 $\Phi$ 4.5 Cortical Screw



### Limited Contact Tibial Metaphysis Plates

**Application:** Tibial metaphyseal fractures.  
**Spec.:** 154mm\*5holes-298mm\*13holes  
**Material:** Titanium  
**Matching Screw:**  $\Phi$ 3.5/5.0 Locking Screw;  
 $\Phi$ 3.5 Cortical Screw;  
 $\Phi$ 3.5 Cancellous Screw



### Distal Lateral Tibial Locking Plates(I)

**Application:** Fractures of lateral distal tibia  
**Spec.:** 117mm\*7holes-225mm\*13holes  
**Material:** Titanium  
**Matching Screw:**  $\Phi$ 3.5 Cortical Screw  
 $\Phi$ 3.5 Locking Screw  
 $\Phi$ 3.5/ $\Phi$ 4.0 Cancellous Screw

### Distal Lateral Fibular Locking Plates

**Application:** Fractures of distal lateral fibula  
**Spec.:** 55mm\*2holes-151mm\*10holes  
**Material:** Titanium  
**Matching Screw:**  $\Phi$ 3.5 Locking Screw;  
 $\Phi$ 3.5 Cortical Screw

### Distal Medial Tibial Locking Plates (III)

**Application:** Fractures of distal medial tibia.  
**Spec.:** 128mm\*4holes-240mm\*11holes  
**Material:** Titanium  
**Matching Screw:**  $\Phi$ 3.5 Locking Screw;  
 $\Phi$ 3.5 Cortical Screw

# Locking Compression Plates System

Trauma\_LCP Systems (Titanium)

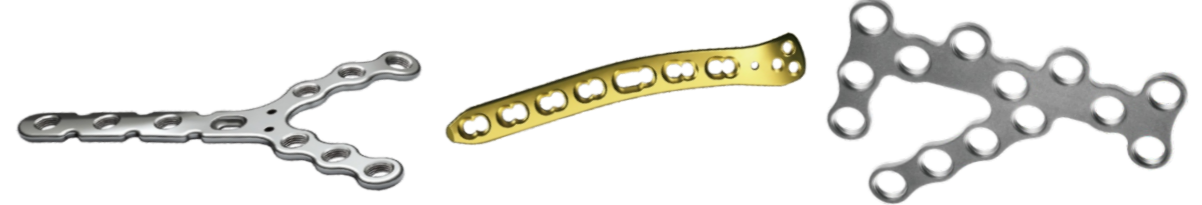

### Reconstruction Distal Humeral Locking Plates (Y-shape)

**Application:** Fractures of distal humerus.  
**Spec.:** 80mm\*3holes-185mm\*10holes  
**Material:** Titanium  
**Matching Screw:**  $\Phi$ 3.5 Locking Screw;  
 $\Phi$ 3.5 Cortical Screw

### Distal Lateral Humeral locking Plate (I), Combined-lock

**Application:** Fractures of lateral distal humerus  
**Spec.:** 67mm\*3holes-139mm\*11holes  
**Material:** Titanium  
**Matching Screw:** 3.5 Cortical Screw  
 2.7/3.5 Locking Screw  
 4.0 Cancellous Screw

### Calcaneus Locking Plates(II)

**Application:** Calcaneus Fractures  
**Spec.:** 14holes  
**Material:** Titanium  
**Matching Screw:**  $\Phi$ 3.5 Locking Screw;  
 $\Phi$ 3.5 Cancellous Screw



### Calcaneus Locking Plates(I)

**Application:** Calcaneus Fractures  
**Spec.:** 11holes-15holes  
**Material:** Titanium  
**Matching Screw:**  $\Phi$ 3.5 Locking Screw;  
 $\Phi$ 3.5 Cancellous Screw

### Calcaneal Locking Plate (VI)

**Application:** Calcaneus Fractures  
 Thickness: 2mm

### Calcaneus Locking Plates(V)

**Application:** Calcaneus Fractures  
**Spec.:** 8holes  
**Material:** Titanium  
**Matching Screw:**  $\Phi$ 3.5 Locking Screw;  
 $\Phi$ 3.5 Cancellous Screw



### Calcaneus Locking Plates(III)

**Application:** Calcaneus Fractures  
**Spec.:** 13holes  
**Material:** Titanium  
**Matching Screw:**  $\Phi$ 3.5 Locking Screw;  
 $\Phi$ 3.5 Cancellous Screw

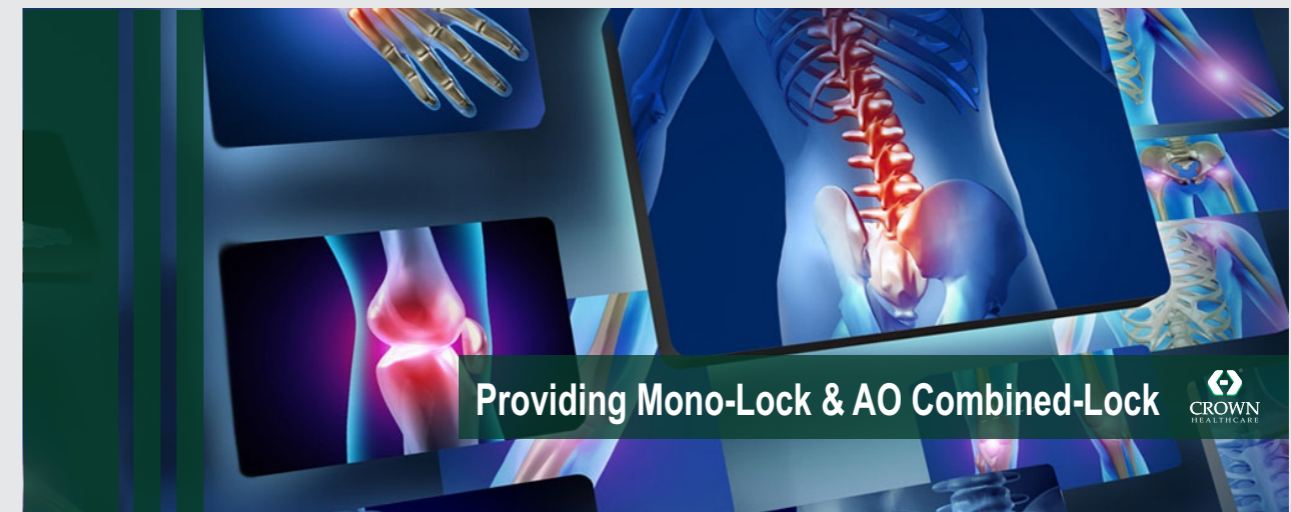

Providing Mono-Lock & AO Combined-Lock





We have a highly reliable, competent and experienced team to educate about our products and provide technical support to surgeons, theatre staff and hospitals whenever called upon with regards to our products.



### Holloware

- Scissors
- Forceps
- Retractors/Towel Clamps
- Needle Holders
- Gynecological Instruments
- Percussion Hammers
- Instrument Tray
- Oral Instruments
- Jars, Sterilisers & Bins

# Surgical Instruments

## Operating Scissors



### OPERATING SCISSORS

Code/Description
INS13-100 Operating Scissors Blunt/Blunt Straight 12.5cm
INS13-104 Operating Scissors Blunt/Blunt Straight 15cm
INS13-106 Operating Scissors Blunt/Blunt Straight 17.5cm
INS13-108 Operating Scissors Blunt/Blunt Straight 20cm
INS13-110 Operating Scissors Blunt/Sharp Straight 12.5cm
INS13-114 Operating Scissors Sharp/Blunt Straight 15cm
INS13-116 Operating Scissors Sharp/Blunt Straight 17.5cm
INS13-118 Operating Scissors Blunt/Sharp Straight 20cm
INS13-120 Operating Scissors Sharp/Sharp Straight 12.5cm
INS13-124 Operating Scissors Sharp/Sharp Straight 15cm
INS13-126 Operating Scissors Sharp/Sharp Straight 17.5cm
INS13-128 Operating Scissors Sharp/Sharp Straight 20cm
INS13-130 Operating Scissors Blunt/Blunt Curved 12.5cm
INS13-134 Operating Scissors Blunt/Blunt Curved 15cm
INS13-136 Operating Scissors Blunt/Blunt Curved 17.5cm
INS13-138 Operating Scissors Blunt/Blunt Curved 20cm
INS13-140 Operating Scissors Blunt/Sharp Curved 12.5cm
INS13-144 Operating Scissors Sharp/Blunt Curved 15cm
INS13-146 Operating Scissors Sharp/Blunt Curved 17.5cm
INS13-148 Operating Scissors Sharp/Blunt Curved 20cm
INS13-150 Operating Scissors Sharp/Sharp Curved 12.5cm
INS13-154 Operating Scissors Sharp/Sharp Curved 15cm
INS13-156 Operating Scissors Sharp/Sharp Curved 17.5cm
INS13-158 Operating Scissors Sharp/Sharp Curved 20cm

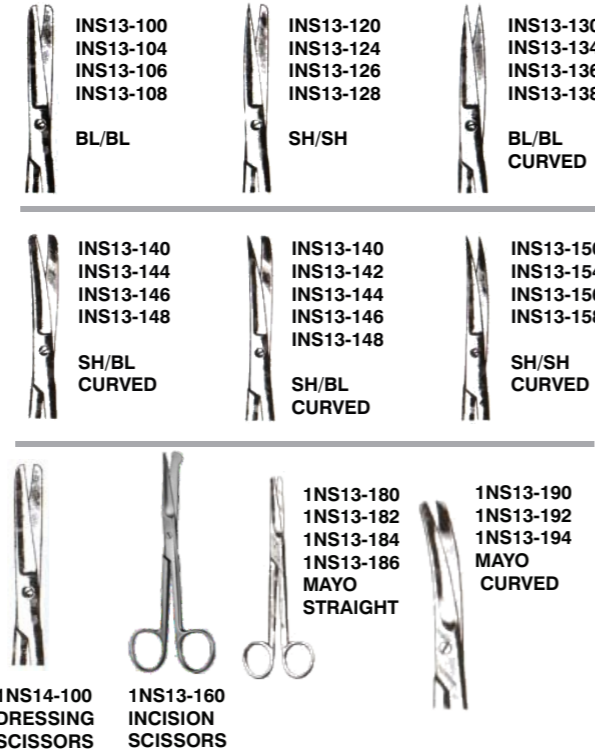

Code/Description
INS13-230 Metzenbaum Scissors Blunt/Blunt Straight 14cm
INS13-232 Metzenbaum Scissors Blunt/Blunt Curved 14cm
INS13-242 Metzenbaum Scissors Curved 20cm
INS13-242 Metzenbaum Nelson Scissors 20cm
INS13-240 Metzenbaum Nelson Scissors 18cm
INS13-244 Metzenbaum Nelson Scissors 23cm
INS13-246 Metzenbaum Nelson Scissors 25cm
INS13-248 Metzenbaum Nelson Scissors 28cm
INS13-250 Metzenbaum Scissors Curved 18cm
INS13-252 Metzenbaum Scissors Straight 20cm

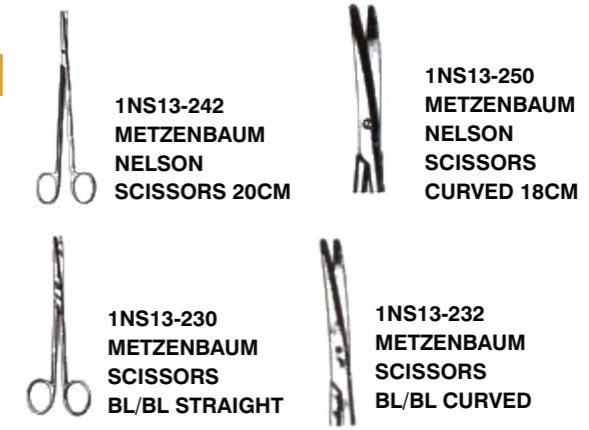

Code/Description
INS13-260 Joseph Operating Scissors 14cm
INS13-280 McIndoe Neuro Scissors 19cm
INS13-300 Tonsil Scissors Yankauer 17.5cm
INS13-360 Heaths Ligature Scissors 15cm
INS13-400 Episitomy Scissors Brown Sadler 14.5cm
INS13-402 Episitomy Scissors Brown Sadler 18cm
INS13-430 Umbilical Scissors USA Patent 10.5cm
INS13-432 Umbilical Scissors USA Patent 12.5cm
INS13-440 Dissecting Scissors Straight 11.5cm
INS13-462 Dissecting Scissors Curved 12.5cm
INS13-482 Uterine Scissors Blunt/Blunt Straight 20cm
INS13-488 Uterine Scissors Blunt/Blunt Straight 24cm

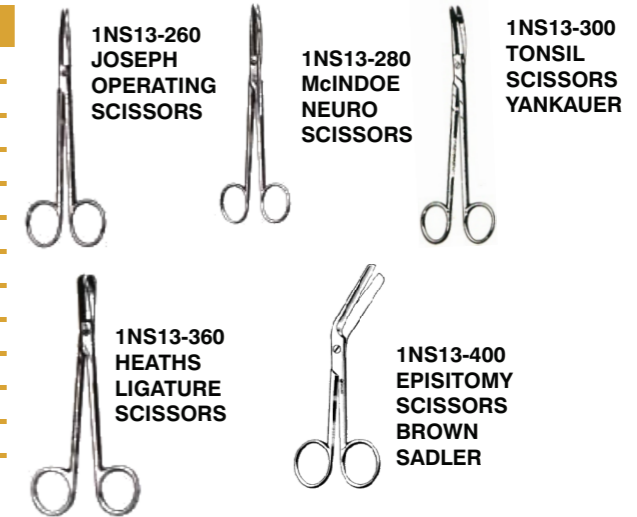

Code/Description
INS13 - 530 Iris Scissors Straight 11cm
INS13 - 532 Iris Scissors Curved 11cm
INS13 - 520 Kelly Scissors (Fitsula) Straight 18cm
INS13 - 750 Spencer Ligature Scissors 13cm



Code/Description
INS14-100 Dressing Scissors Straight 12.5cm
INS14-101 Dressing Scissors Straight 15cm
INS14-102 Dressing Scissors Straight 17.5cm
INS14-103 Dressing Scissors Straight 20cm
INS13-160 Incision Scissors 13cm
INS13-170 Deaver Operating Scissors Sharp/Blunt Straight 14cm
INS13-172 Deaver Operating Scissors Sharp/Blunt Curved 14cm
INS13-200 Mayo Stille Operating Scissors Sharp/Sharp Straight 15cm
INS13-210 Mayo Stille Operating Scissors Blunt/Blunt Curved 14cm
INS13-220 Lexer Operating Scissors Straight 16cm
INS13-222 Lexer Operating Scissors Curved 16cm



# Surgical Instruments

## Dressing & Tissue Forceps



Code/Description
INS3 - 140 Magill Catheter Introducing forcep Adult 24cm
INS3 - 142 Magill Catheter Introducing forcep Child 20cm
INS15 - 100 Dissecting forceps English TOE Plain 10cm
INS15 - 102 Dissecting forceps English TOE Plain 12.5cm
INS15 - 104 Dissecting forcep English TOE Plain 14cm
INS15 - 106 Dissecting forceps English TOE Plain 18cm
INS15 - 108 Dissecting forceps English TOE Plain 20cm

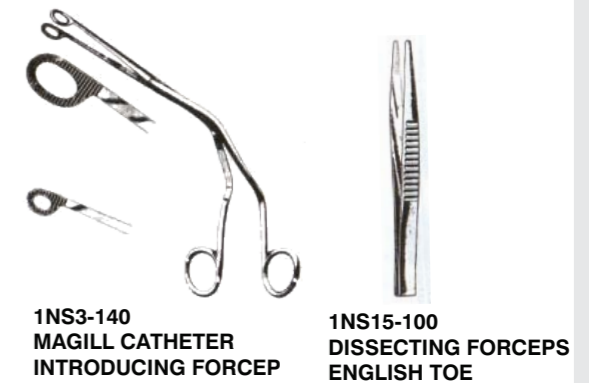

Crown Surgical Instruments  
A Hallmark of Trust



# Surgical Instruments

## Dressing & Tissue Forceps



Code/Description
INS15 - 132 Treve Tissue forceps 15cm
INS15 - 142 Tissue Dissecting forcep toothed 1x2 14cm
INS15 - 143 Tissue Dissecting forcep toothed 1x2 16cm
INS15 - 144 Tissue Dissecting forcep toothed 1x2 18cm
INS15 - 152 Tissue Dissecting forcep toothed 2x3 14cm
INS15 - 156 Tissue Dissecting forcep toothed 2x3 18cm
INS15 - 162 Potts-Smith Tissue forceps toothed 1x2 21cm
INS15 - 164 Tissue Dissecting forceps toothed 2x3 16cm

Code/Description
INS51 - 190 Allis Tissue Forceps 15cm 4 x 5 toothed
INS51 - 200 Allis Tissue Forceps 15cm 4 x 5 toothed clipped
INS15 - 202 Potts-Smith Tissue forces Plain 21cm

Code/Description
INS15 - 300 Adson Dissecting Forceps 12cm
INS15 - 330 Adson Dissecting Forceps 1 x 2 toothed 12cm
INS15 - 390 Boney Tissue Forceps 1x2 toothed 18cm
INS15 - 400 Boney Tissue Forceps 2x3 toothed 18cm

Code/Description
INS15 - 412 Lane Tissue Forceps 1 x 2 toothed 15cm
INS15 - 414 Lane Tissue Forceps 1 x 2 toothed 18cm
INS15 - 440 Lane Tissue Forceps 2 x 3 toothed 15cm
INS15 - 442 Lane Tissue Forceps 2 x 3 toothed 18cm

Code/Description
INS19 - 790 Lister Sinus Forceps 12.5cm
INS19 - 792 Lister Sinus Forceps 15cm
INS19 - 810 Bryant Sinus Dressing forceps 12.5cm
INS19 - 820 Bryant Sinus Dressing forceps 12.5cm Serrated

Code/Description
INS16 - 100 Dressing Forceps TOE 10cm
INS16 - 102 Dressing Forceps TOE 12.5cm
INS16 - 104 Dressing Forceps TOE 15cm
INS19 - 832 French Dressing Forceps 12.5cm Curved
INS19 - 830 French Dressing Forceps 12.5cm Straight
INS 19 - 840 Gross Dressing forceps 14cm Straight
INS 19 - 842 Gross Dressing forceps 16cm Straight
INS 19 - 850 Gross Dressing forceps 14cm Curved
INS 19 - 860 Gross Dressing forceps 18cm Straight
INS 19 - 862 Gross Dressing forceps 20cm Straight
INS 19 - 870 Gross Dressing forceps 18cm Curved
INS 19 - 872 Gross Dressing forceps 20cm Curved
INS 19 - 952 Gross Dressing forceps 16cm Curved

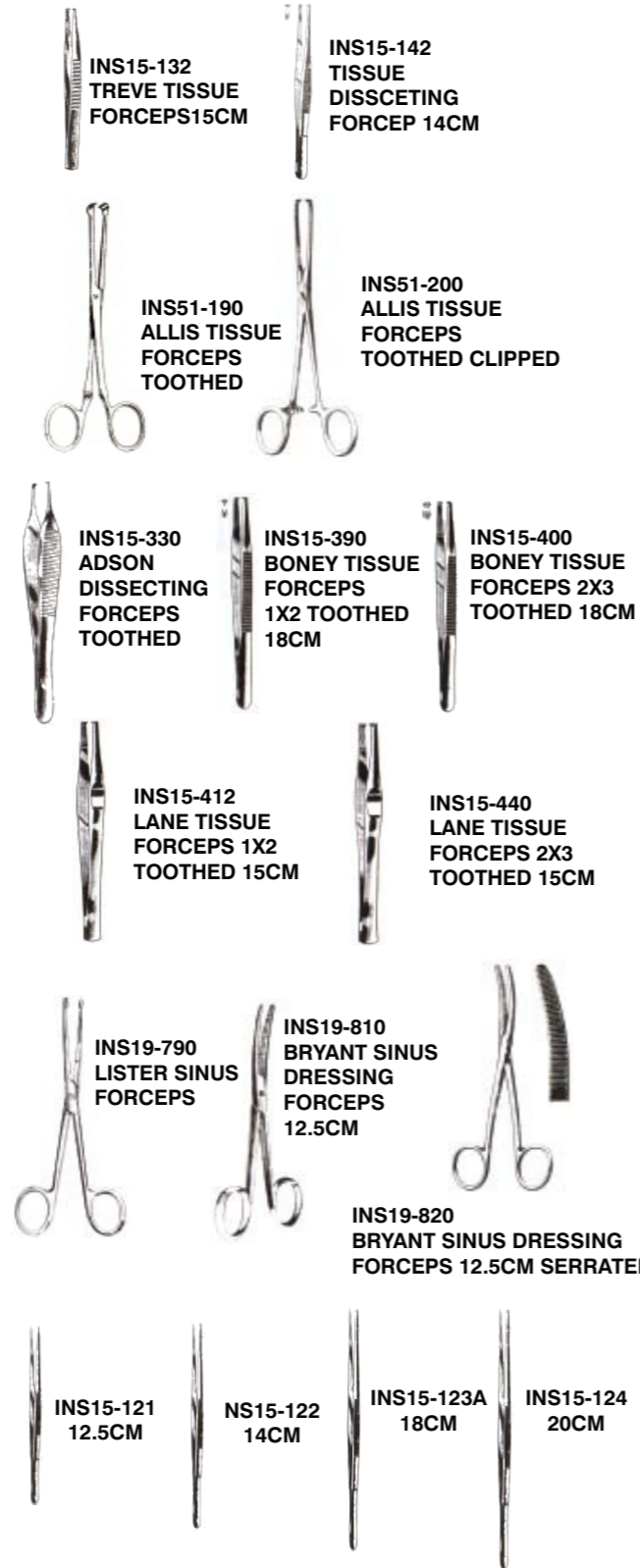

# Surgical Instruments

## Haemostatic & Artery Forceps



Code/Description
INS17 - 120 Hartman Haemostatic forceps 10cm Straight
INS17 - 122 Hartman Haemostatic forceps 10cm Curved
INS17 - 280 Spencerwells Artery forceps straight 12.5cm
INS17 - 290 Spencerwells Artery forceps curved 12.5cm
INS17 - 282 Spencerwells Artery forceps straight 15cm
INS17 - 284 Spencerwells Artery forceps straight 18cm
INS17 - 286 Spencerwells Artery forceps straight 20cm
INS17 - 292 Spencerwells Artery forceps curved 15cm
INS17 - 294 Spencerwells Artery forceps curved 18cm

Code/Description
INS17 - 170 Artery Forceps Crille Straight 14cm
INS17 - 172 Artery Forceps Crille Curved 14cm
INS17 - 354 Artery Forceps Kocher straight 15cm
INS17 - 356 Artery Forceps Kocher straight 18cm
INS17 - 358 Artery Forceps Kocher straight 20cm
INS17 - 364 Artery Forceps Kocher curved 15cm
INS17 - 366 Artery Forceps Kocher curved 18cm
INS17 - 368 Artery Forceps Kocher curved 20cm
INS17 - 340 Dunhill Artery Forceps Curved 12.5cm

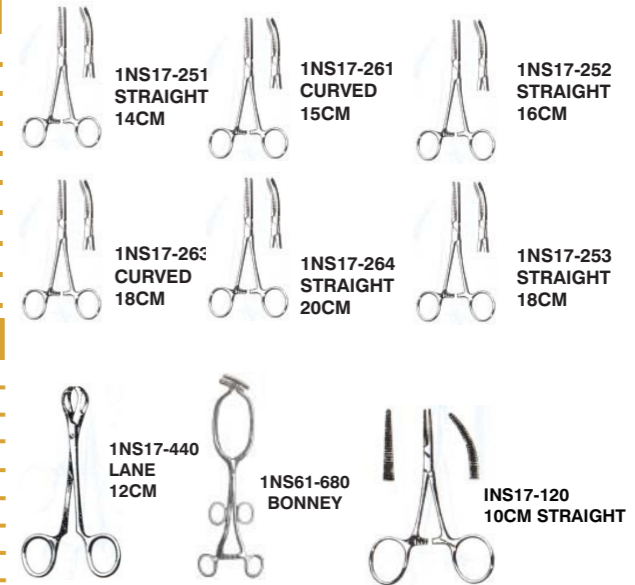

## Sponge Holding Forceps

Code/Description
INS19 - 962 Bozeman Sponge Holding Forceps 26cm
INS19 - 990 Ballenger Sponge Holding Forceps 18cm Straight
INS19 - 992 Ballenger Sponge Holding Forceps 18cm Curved
INS19 - 1000 Ballenger Sponge Holding Forceps 18cm Serrated Straight
INS19 - 1002 Ballenger Sponge Holding Forceps 18cm Serrated Curved
INS19 - 1020 Foerster Sponge Holding forceps 25cm Serrated Straight
INS19 - 1022 Foerster Sponge Holding forceps 25cm Serrated Curved
INS19 - 1030 Rampley Sponge Holding forceps str 18cm
INS19 - 1032 Rampley Sponge Holding forceps str 25cm
INS19 - 1040 Rampley Sponge Holding forceps Curved 18cm
INS19 - 1042 Rampley Sponge Holding forceps Curved 25cm

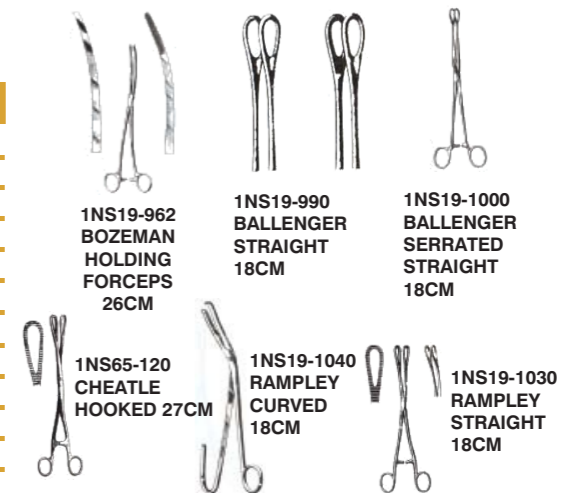

## Intestinal Forceps

Code/Description
INS51 - 220 Lockwood Intestinal Forceps 29cm
INS51 - 230 Allis-Adair Intestinal forceps 15.5cm
INS51 - 260 Littlewoods Forceps 2 x 3 19cm
INS51 - 300 Bobcock forceps 16cm
INS51 - 302 Bobcock forceps 18cm
INS51 - 304 Bobcock forceps 20cm
INS51 - 340 Duval Forceps 18cm
INS51 - 342 Duval Collin Forceps 20cm
INS51 - 292 Lane Intestinal Forceps 15cm

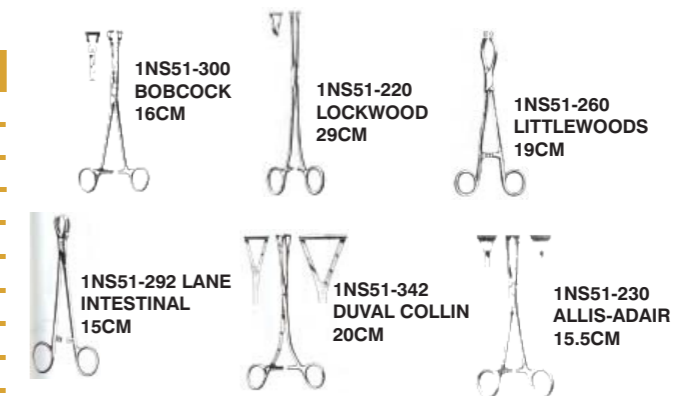



# Surgical Instruments



## Retractors / Towel Clamps

Code/Description
INS17 - 910 Backhaus Towel Clamps 8cm
INS17 - 912 Backhaus Towel Clamps 10cm
INS17 - 914 Backhaus Towel Clamps 13cm
INS21 - 120 US Army Retractor 21cm

Code/Description
INS21 - 240 Langenbeck Retractors 21cm 30 x 14mm
INS21 - 244 Langenbeck Retractors 21cm 30 x 16mm
INS21 - 246 Langenbeck Retractors 21cm 40 x 11mm
INS21 - 320 Morris Retractors 90mm
INS21 - 322 Morris Retractors 100mm
INS21 - 324 Morris Retractors 115mm
INS21 - 330 Morris Retractors Double Ended

Code/Description
INS21 - 472 Collin Self Retaining Retractor Centre Blade
INS21 - 280 Richardson Retractors 28 x 20mm
INS21 - 282 Richardson Retractors 36 x 28mm 24cm
INS21 - 284 Richardson Retractors 44 x 38mm
INS21 - 192 Meyering Retractor 18cm 7x4mm
INS21 - 500 Balfour Retractor
INS21 - 270 Czerny Retractor 21cm 32 x 22mm
INS21 - 290 Richardson East Retractor Double Ended 26cm
INS21 - 292 Richardson East Retractor Double Ended 28cm
INS21-390 Dartigues Retractor
INS61-160 Jackson Retractors Small
INS61-162 Jackson Retractors Medium
INS61-164 Jackson Retractors Large

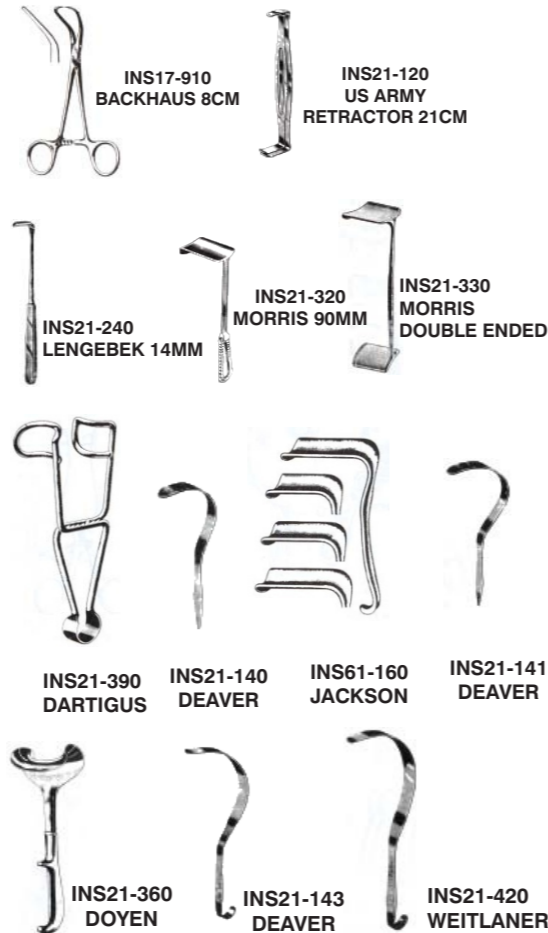

## Retractors / Towel Clamps

Code/Description
INS21 - 430 West Retractors 13cm
INS21 - 100 Farabeuf Twin Retractor Curved 12cm
INS21 - 102 Farabeuf Twin Retractor Straight 15cm
INS22 - 100 Canny Ryall Retractor 16 x 25mm
INS51 - 480 Lane Double Ended Intestinal Clamp Colines 30cm
INS51 - 490 Lane Intestinal Clamp Twin 30cm

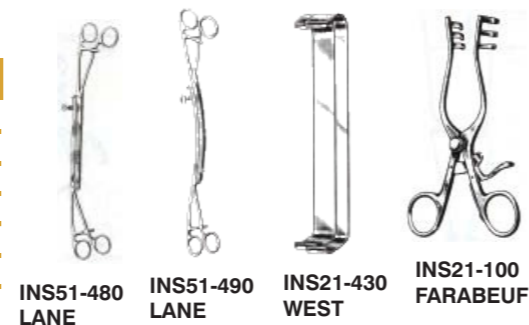

## Obstetrical Forceps

Code/Description
INS63 - 150 Wrigley Obstetrical Forceps 27cm
INS63 - 300 Barnes-Naville Obstetrical Forceps
INS63 - 440 Pelvimeter Martin 33cm
INS63 - 450 Collin Pelvimeter 35cm
INS63 - 470 Pelvimeter Briesky 33cm
INS63 - 530 Saenger Placenta Forceps Straight 27cm
INS63 - 532 Saenger Placenta Forceps Curved 27cm

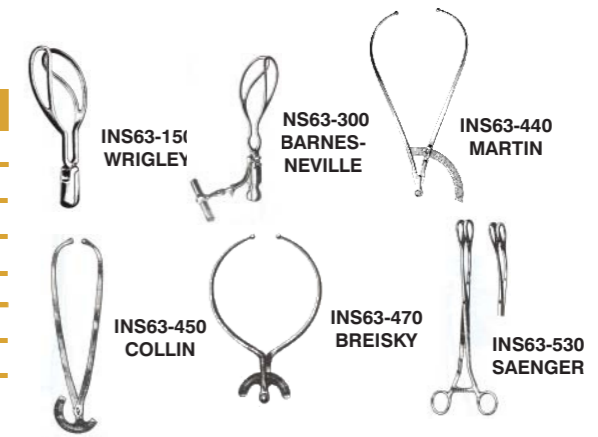

## Obstetrical Hooks



## Needle Holders

Code/Description
INS23 - 150 Mayo Safety Pin
INS23 - 170 Needle 13cm
INS25 - 120 Webster Needle Holder 13cm
INS25 - 200 Bozeman Needle Holder 20cm
INS25 - 100 Derf Needle Holder 12cm
INS25 - 130 Mayo Hegar needle holder 14
INS25 - 131 Mayo Hegar needle holder 16
INS25 - 132 Mayo Hegar needle holder 18
INS25 - 133 Mayo Hegar needle holder 20
INS25 - 150 Crilemurray Needle Holder 15cm

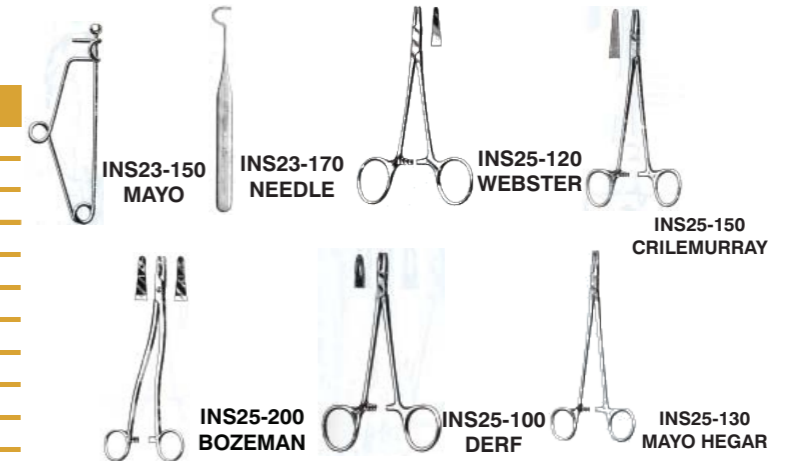

## Gynecological Instruments

Code/Description
INS61 - 110 Vaginal specula Cusco small
INS61 - 112 Vaginal specula Cusco medium
INS61 - 114 Vaginal specula Cusco large
INS61 - 140 Vaginal specula Sims small
INS61 - 142 Vaginal specula Sims medium
INS61 - 144 Vaginal specula Sims large
INS61 - 120 Vaginal specula Graves Small
INS61 - 122 Vaginal specula Graves Medium
INS61 - 124 Vaginal specula Graves large
INS61 - 200 Auvard Weighted 2.5lbs Vaginal Speculum
INS61 - 202 Auvard Weighted 3.0lbs Vaginal Speculum

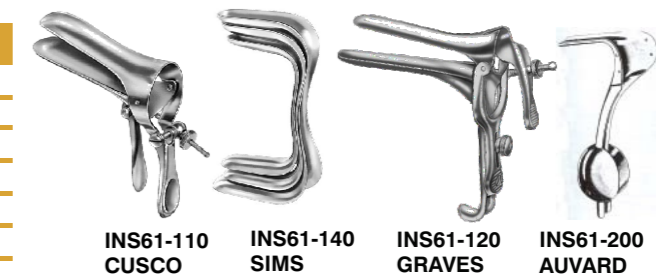

# Surgical Instruments



## Gynecological Instruments

Code/Description
INS61 - 240 Bozeman Forceps Curved 26cm
INS61 - 280 Uterine Dilators Hegar (Set of 14) 4mm - 17mm
INS61 - 290 Uterine Dilators Hegar (Set of 8) 3/4 to 17/18
INS61 - 330 Wylie Dilators 29cm
INS61 - 340 Goodell Dilators 34cm
INS61 - 390 Sims Uterine sound 32cm



Code/Description
INS61 - 440 Tenaculum forceps Schroeder 25cm Slim
INS61 - 450 Tenaculum forceps Schroeder 25cm Broad



Code/Description
INS61 - 690 Uterine Polypus forceps Noto 27cm
INS61 - 700 Uterine Polypus forceps Kelly 32cm
INS61 - 710 Uterine Elevators Dartigues 27cm
INS61 - 800 Uterine Curette Double Ended Blake 27cm
INS61 - 810 Uterine Curette Double Ended Zweifel 31cm
INS61 - 870 Uterine curettes sims sharp Fig 2, Fig 3, Fig 4
INS61 - 880 Uterine curettes sims blunt Fig 2, Fig 3 Fig 4
INS63 - 480 Umbilical Clamp Kane 8.5cm



Code/Description
INS63 - 510 Ovum Heyewood Smith Forceps Straight 25.5cm
INS63 - 520 Ovum Forceps - Corey 24cm
INS63 - 550 Green Armytage Forceps 21cm
INS63 - 572 Bozeman - Fritsch Femal Catheter 10mm

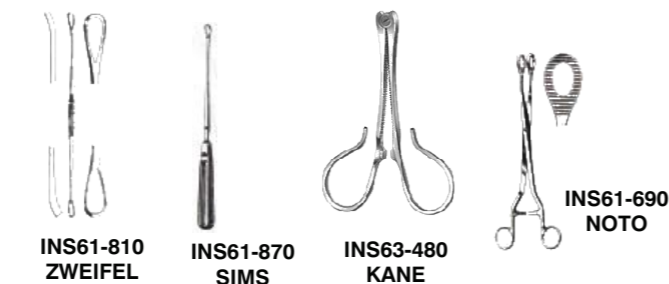

Code/Description
INS27 - 104 Plaster Lister scissors 14cm
INS27 - 106 Plaster Lister scissors 18cm
INS27 - 108 Plaster Lister scissors 20cm
INS27 - 160 Plaster shears wire clothing 20cm
INS27 - 190 Plastic shears stille 23cm
INS27 - 194 Plastic shears stille 37cm



Code/Description
INS29 - 144 Bone Chisels osteotomes 12cm
INS29 - 146 Bone Chisels osteotomes 14cm
INS29 - 200 Bone Mellets 24cm
INS29 - 270 Volkman Currettes 13cm
INS29 - 272 Volkman Currettes 16.5cm
INS29 - 602 Bone cutting forceps Liston 17cm
INS29 - 606 Bone cutting forceps Liston 22cm
INS 39-200 Barker Curette
INS 39-210 Krause Polypus Snares



# Surgical Instruments



## Otology

Code/Description
INS5-210 Lichtwitz Trocar . 00
INS39 - 140 Ear specula pimeory syringe 50cc
INS39 - 142 Ear specula pimeory syringe 75cc
INS39 - 144 Ear specula pimeory syringe 100cc
INS39 - 146 Ear specula pimeory syringe 150cc
INS39 - 230 Ear Dressing forcep 12cm
INS39 - 240 Ear Dressing forcep 14cm

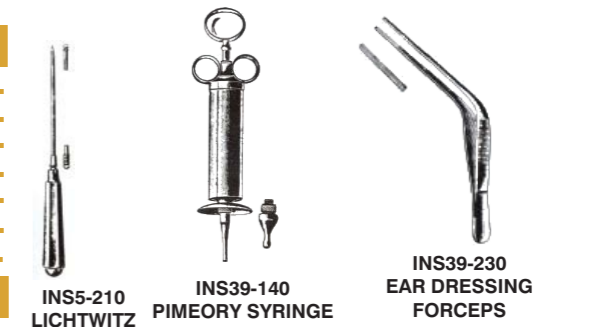

Code/Description
INS39 - 260 Polypus & Foreign body forceps Hartrans 12cm
INS39 - 270 Polypus & Foreign body forceps Hartrans 14cm
INS39 - 290 Ear forceps Hartmans 14cm
INS39 - 291 Ear forceps Hartmans 8.5cm
INS39 - 293 Ear forceps Hartmans 8.5cm Serrated
INS39 - 294 Ear forceps Hartmans Serrated 14cm
INS13 - 320 Heyman Nazal Scissors 18cm
INS41 - 200 Heymann-Knight Dressing Forceps 19cm
INS41 - 210 Hartmann Dressing Forceps 20cm



Code/Description
INS41 - 110 Killian Nazal Specula Fig 1,2,3,4
INS41 - 100 Vienna Nazal Specula Adult
INS41 - 102 Vienna Nazal Specula Child
INS41 - 104 Vienna Nazal Specula Infant
INS 41 - 130 Nazal Specula - St Clair Thomson Fig 1
INS 41 - 132 Nazal Specula - St Clair Thomson Fig 2
INS 41 - 134 Nazal Specula - St Clair Thomson Fig 3
INS 41 - 220 Luc Nazal Cutting forceps 20cm
INS 41 - 222 Luc Nazal Cutting forceps 20cm Serrated
INS 41 - 480 Eicken Killian Sinus Cannula 3mm
INS43 - 170 Heister Mouth Gag 13cm
INS45 - 242 Punch forceps - Hartmann 15cm
INS47 - 100 Laryngeal forceps - Fraenkel 18cm
INS47 - 123 Chevalier Jackson cup Biopsy forceps 40cm Fig 4



## GENERAL INSTRUMENTS

Code/Description
INS23 - 100 Probes 11.5cm
INS23 - 111 Probes 12.5cm
INS23 - 112 Probes 14cm
INS23 - 113 Probes 16cm
INS23 - 114 Probes 18cm
INS23 - 115 Probes 20cm
INS23 - 116 Probes 25cm
INS23 - 144 Probe Director 16cm
INS- BH3 Blade Holders 3
INS- BH4 Blade Holders 4
INS- Bh7 Blade Holders 7

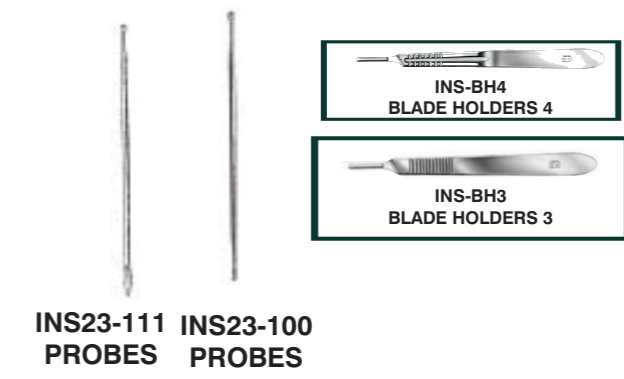

### SKIN GRAFTING BLADE HOLDER

INS-SGB	Skin Grafting Blade Holder
---------	----------------------------



HOLLOWWARE

# Surgical Instruments



## Percussion Hammers

Code/Description
INS5 - 210 Lichtwitz Trocar
INS39 - 140 Ear specula pimeory syringe 50cc
INS39 - 142 Ear specula pimeory syringe 75cc
INS39 - 144 Ear specula pimeory syringe 100cc
INS39 - 146 Ear specula pimeory syringe 150cc
INS39 - 230 Ear Dressing forcep 12cm
INS39 - 240 Ear Dressing forcep 14cm
INS1 - 310 Taylor Percusison Hammer
INS1 - 330 Dejerine Percussion Hammer
INS1 - 350 Buck Percussion Hammer

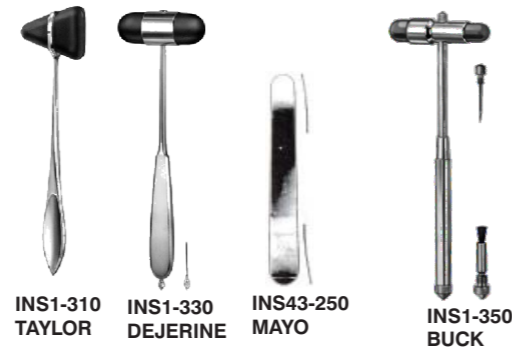

## INSTRUMENT SETS

INS-DSETS 1	Minor Delivery Set
INS-DSET 2	Major Delivery Set
INS-SUTSET	Suture Set
INS-DRESSSET	Dressing Set
INS-CEASSET 1	Minor Ceasarian Set
INS-CEASSET 2	Major Ceasarian Set
INS-GENSET 1	Minor General Set
INS-GENSET 2	Major General Set
INS-CATSET	Catract Set
INS-LAPSET	Laparatomy Set
INS-DCSETS	D & C Sets

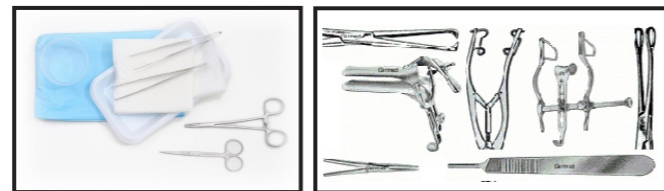

Suture Set

## Oral Instruments

INS43 - 250	Tongue Depressors Mayo 19cm
INS43 - 170	Tonsil forceps Forcpes 19cm

## Dental Instruments

INS-DSTFCPS	Dental Set of Tooth Extracting Forceps Adult (10 pieces)
INS-DSTCHLD	Dental Set of Tooth Extracting Forceps Children Dental Set
INS-SCALSING	Scaler Sets Single Set of 10's
INS-SCALDEND	Sacler Sets D/Ended
INS-PKTHOMAS	PK Thomas Sets
INS-LABSETS	Laboratory Sets
INS-IMPTRAYS	Impression Trays
INS-PGUSN	Pressure Guns
INS-SYRINGE	Catridge Syringe 1.8ml
INS-MRETAINER	Matrix Retainer
INS-TOFFRETAN	Tofflemore
INS-2460	Ivory 12
INS-3176	Measuring Guage (Metal)
INS-CREMOV	Crown Removers
INS-LECRONL	Lecron Large
INS-ZALEH	Zaleh



Dental Set of Tooth Extracting Forceps



Tofflemore



Crown Removers

## DENTAL INSTRUMENTS CONT'D

INS-FINSTR	Filling Instruments - Various available
INS-CSPATULA	Cement Spatula
INS-PKNIFES	Plaster Knife
INS-PSPATULA	Plaster Spatula
INS-2200/1	Wax Knives (small)
INS-2200/2	Wax Knives (large)
INS-RNPLIERS	Round Nose Pliers
INS-FNPLIERS	Flat Nose Pliers
INS-PEASOPL	Peaso Pliers
INS-WCUTTER	Wire Cutters
INS-820/11/12	Luer Bone Ronguers
INS-MMIRROM	Mouth Mirrors (magnifying)
INS-MMIRROP	Mouth Mirrors (Plain)
INS-EXPLORER	Explorers S/Ended
INS-UNIPLASERS	Universal Plasers

# Surgical Instruments



## Kidney Dishes Stainless Steel

Code/Description
H-KD006 Kidney Dishes small 6" MH-010
H-KD008 Kidney Dishes medium 8" MH-020
H-KD010 Kidney Dishes large 10" MH-030
H-KD012 Kidney Dishes extra large 12" MH-040



Kidney Dishes 6"

Kidney Dishes 8"

Kidney Dishes 10"

Kidney Dishes 12"

## Gallipots Stainless Steel

Code/Description
H-GP003 Gallipot with lid 10 oz
H-GP004 Gallipots without lids 4oz MH-070
H-GP006 Gallipots without lids 6oz MH-080
H-GP008 Gallipots without lids 8 oz MH-090
H-GP010 Gallipots without lids 10 oz MH-100
H-GP012 Gallipots without lids 12 oz MH-110



Gallipot with Lid 10 oz

Gallipot without Lid 4 oz

## Bed Pans & Urinals Stainless Steel

Code/Description
H-BP010 Bed Pan - Female (Round) Std Size
H-BP015 Bed Pan - Perfection type Std Size
H-UN010 Urinal Vertical Female Std Size
H-UN005 Urinal Vertical Male Std Size



Bed Pan Male Std. Size

Bed Pan Male Std. Size

# Surgical Instruments



## Instrument Trays With Lids Stainless Steel

Code/Description
H-IT005 Instrument Trays with Lids 8" x 6" x 2" MH-160
H-IT010 Instrument Trays with Lids 9" x 5" x 2" MH-170
H-IT020 Instrument Trays with Lids 10" x 8" x 2" MH-180
H-IT015 Instrument Trays with Lids 12" x 8" x 2" MH-190
H-IT025 Instrument Trays with Lids 12" x 10" x 2" MH-200
H-IT030 Instrument Trays with Lids 14" x 10" x 2" MH-210
H-IT035 Instrument Trays with Lids 15" x 12" x 2" MH-220
H-IT040 Instrument Trays with Lids 18" x 12.5" x 2.5" MH-230



# Surgical Instruments



## Jars, Sterilisers & Bins

### Dressing, Forceps & Thermometer Jars

Code/Description
H-DJ005 Dressing Jar 4"x2"
H-DJ010 Dressing Jar 4"x5"
H-FJ005 Forcep Jar 55x110mm Small
H-FJ010 Forcep Jar 55x140mm Medium
H-FJ015 Forcep Jar 55x180mm Large
H-TJ005 Thermometer Jar 30x 80mm std Size



## Surgical Instrument Boxes - Stainless Steel & Aluminium

Code/Description
H-SBX020 Surgical Instrument Box Aluminium 17.5x7.5x3.5cm
H-SBX025 Surgical Instrument Box Aluminium 18.5x9.5x3cm
H-SBX030 Surgical Instrument Box Aluminium 21.5x10.5x4cm
H-SBX005 Surgical Instrument Box Stainless Steel 18x8x4cm
H-SBX010 Surgical Instrument Box Stainless Steel 20x9x4cm
H-SBX015 Surgical Instrument Box Stainless Steel 25x10x5cm

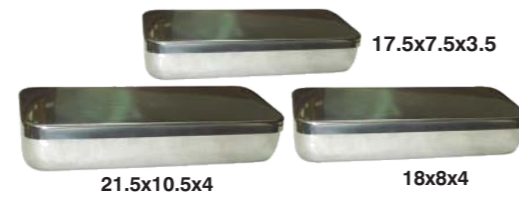

### Instrument Steriliser & Bins

H-IS020 Instrument Steriliser Seamless with Thermostat 12" x 6" x 5"
H-IS025 Instrument Steriliser Seamless with Thermostat 18" x 8" x 6"
H-IS0030 Instrument Steriliser Seamless with Thermostat 20" x 8" x 6"
H-IS005 Instrument Steriliser Standard 12" x 6" x 5"
H-IS010 Instrument Steriliser Standard 18" x 8" x 6"
H-IS015 Instrument Steriliser Standard 20" x 8" x 6"
SP-810 Element for Instrument Sterilizer (UPL)
H-PB005 Pedal Bins - Stainless Steel 12 litres



## Sterilising Drums Stainless Steel

Code/Description
H-SD005 Sterilising Drums 4" x 4" (100mm x 100mm)
H-SD010 Sterilising Drums 6" x 6" (150mm x 150mm)
H-SD015 Sterilising Drums 7" x 7" (180mm x 180mm)
H-SD020 Sterilising Drums 9" x 9" (225mm x 225mm)
H-SD025 Sterilising Drums 11" x 9" (275mm x 225mm)
H-SD030 Sterilising Drums 12" x 6" (300mm x 150mm)
H-SD035 Sterilising Drums 14" x 6" (350mm x 150mm)
H-SD040 Sterilising Drums 14" x 10" (354mm x 254mm)
H-SD045 Sterilising Drums 15" x 12" (375mm x 300mm)



## Basins & Lotion Bowls

Code/Description
H-SB015 Basin 3 L
H-SB020 Basin 4 L
H-SB025 Basin 7 L
H-LB004 Lotion Bowls 4"
H-LB005 Lotion Bowls 5"
H-LB006 Lotion Bowls 6"



# Surgical Instruments



Hollower

## Buckets Stainless Steel

Code/Description
H-SB005 Bucket 10.5" x 9.5"
H-SB010 Bucket 13" x 12"



## Sputum Mugs, Irrigator Sets / Measuring Jug

Code/Description
H-SM001 Sputum Mug
H-ES005 Irrigator Set - Full Kit 1.0 litre
H-ES010 Irrigator Set - Full Kit 1.5 litre
H-ES015 Irrigator Set - Full Kit 2.0 litre
H-MJ001 Measuring Jug Graduated 1000ml



Full Kit 1.5 Litre      Full Kit 2.0 Litre      Measuring Jug

## Catheter Trays Stainless Steel

Code/Description
H-CT005 Catheter Trays 8" x 1.5"
H-CT010 Catheter Trays 10" x 2"
H-CT015 Catheter Trays 16" x 2"

Code/Description
H-KDP008 Kidney Dishes Plastic Autoclavable 8"
H-KDP010 Kidney Dishes Plastic Autoclavable 10"
H-UN015 Urinal Plastic Male
H-UN020 Urinal Plastic Female
H-BP020 Bed Pan Plastic



Catheter Tray 8"x1.5"

## Plastic Autoclavable

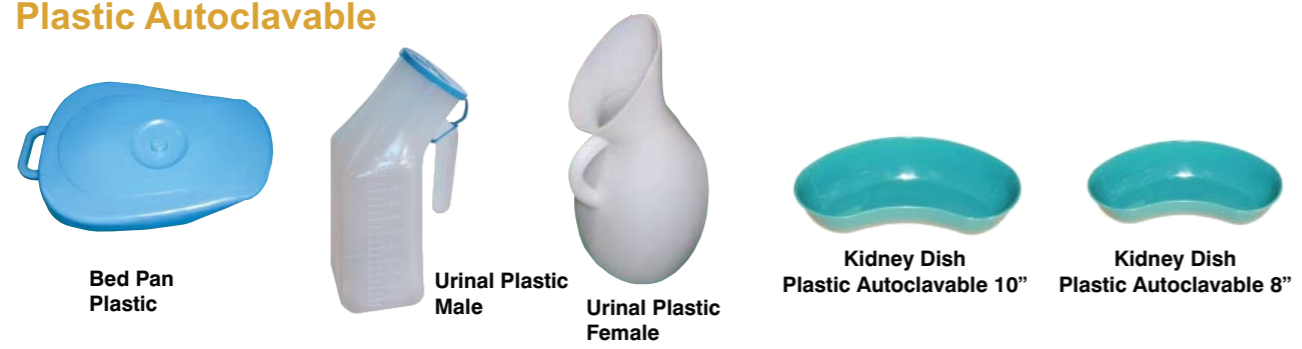

Bed Pan Plastic

Urinal Plastic Male

Urinal Plastic Female

Kidney Dish Plastic Autoclavable 10"

Kidney Dish Plastic Autoclavable 8"



